



MILLING | TURNING | CUT-OFF

2024 FALL - 2025 WINTER

# PROMO PACK

Offers valid through  
March 31, 2025

## KYOCERA PRECISION TOOLS (KPT)

KYOCERA Precision Tools (KPT) is a division of the KYOCERA SGS Precision Tools Group specializing in the manufacturing, servicing, and marketing of Indexable Cutting Tools. With over 40 years of cutting tool expertise, KYOCERA has become the market-leader in Japan and has an established global presence with manufacturing, technical centers and sales offices in the Americas, Europe, and Asia.



## CUTTING-EDGE, COST-EFFICIENT SOLUTIONS

At KYOCERA Precision Tools, we craft cutting-edge indexable tools that elevate your machining prowess to unparalleled heights. Our creations not only meet but surpass the lofty standards of the modern metalworking aficionado, delivering the pinnacle of quality while respecting the bottom line.

From our origins rooted in ceramic technologies, we've evolved into a global powerhouse in metal removal innovation. Our arsenal includes carbide, cermet, CBN, and PCD solutions, each meticulously designed to outshine the competition.

For over four decades, we've relentlessly pursued perfection, birthing groundbreaking tools that redefine industry standards, including the **MEC Ultra-Hurricane 90° Milling Cutters**, the **MFH-Raptor High-Feed Milling Cutters**, the peerless **DRZ & DRV Family of Magic Drills**, and the trailblazing **CCX, the world's premier CVD Coated Cermet**.

Join the elite league of machinists who demand nothing but the best. Embrace KYOCERA Precision Tools and let your craftsmanship shine brighter than ever before.



## PRODUCTS



Turning & Boring



Holemaking



Indexable Milling



Small Tools for Swiss Lathes



Quick-Change Tooling & Specialty Tools



Grooving & Cut-Off

## MARKETS SERVED



Aerospace



Automotive



Medical & Dental



Power Generation



Oil & Gas

# Milling Solutions

Cost-Efficient Kits Featuring (1) Milling Cutter and (10) Inserts

**MA90 Series** P M K S H

Multi-Functional 90° Milling with Tangential Inserts

Page 4

**MB45 Series** P M K N S H

General Purpose 45° Milling with Economical 8-Edge Inserts

Page 10

# Turning Solutions

Cost-Efficient Kits Featuring (1) Toolholder and (10) Inserts

**CA115P / CA125P** P

Steel Turning Grades with Next-Generation CVD Coating Technology

Page 18

**PR115S / PR120S** M S

Stainless Steel and Heat-Resistant Alloy Turning with New PVD Coating Technology

Page 24

# Small Part Cut-Off Solutions

Cost-Efficient Kits Featuring (1) Toolholder and (10) Inserts

**KGZ** P M

Cut-Off System for Small Parts Machining

Page 28

**Find a Distributor Near You**

[www.KyoceraPrecisionTools.com/locate](http://www.KyoceraPrecisionTools.com/locate)

**Contact a Sales Engineer**

[www.KyoceraPrecisionTools.com/sales](http://www.KyoceraPrecisionTools.com/sales)



# MA90 Series

Tangential 90° Milling with 4-Edge Inserts



View Online



Product Video



Product Brochure

Original tangential 90° end mill with economical 4-edge inserts

New grade PR18 Series and unique insert cutting edge design creates high-quality machining with longer tool life

The MA90 tangential end mills provide a large variety of machining operations

## Challenges

### Conventional end mill

- Sudden fractures can cause damage to the holder
- Insert defects preventing use of all four edges

### Tangential end mill

- Premature tool wear can quickly deteriorate the surface finish quality
- Poor wall accuracy

## SOLUTION

Kyocera's MA90 tangential end mill solves these problems with a unique insert shape and PR18 Series grade coating technology.

## Large web thickness

High rigidity

## Peripheral grinding specifications

Excellent wall accuracy

## Special wiper edge

Large relief angle suppresses wear  
High-quality surface finish



2024 Fall - 2025 Winter Promo Pack Offers valid through March 31, 2025

All promotional items are available exclusively through Authorized North American KYOCERA Precision Tool Distributors.

Please use specified Promo Code or Kit Part Number when placing orders. To locate a distributor visit [www.kyoceraprecisiontools.com/locate](http://www.kyoceraprecisiontools.com/locate).

# PR18 Series

Next-generation insert grade for milling

Kyocera's Nano Layer Coating Technology

Longer Tool Life with Next-generation Coating for Milling

New insert grades PR18 Series provides significantly longer tool life



**Double Lamination Technology  
Maintains Longer Tool Life**

Multi-layer structure with two unique nano layers  
Superior abrasion resistance and fracture resistance

## Multi-functional (G-class insert)

Supports three-dimensional machining

## Unique cutting edge design

Excellent fracture resistance and low cutting force design

## Newly developed insert grade

MEGACOAT NANO EX

PR18 Series delivers longer tool life

KYOCERA Precision Tools

P : 800.823.7284 • E : [ctsales@kyocerapti.com](mailto:ctsales@kyocerapti.com)

Official Website : [www.kyoceraprecisiontools.com](http://www.kyoceraprecisiontools.com) • Distributor Website : [portal.kyoceraprecisiontools.com](http://portal.kyoceraprecisiontools.com)

# MA90 Face Mill Kits

Includes (1) Cutter and (10) Inserts

Choose your Cutter, Insert Grade, and Chipbreaker



MA90 MILLING KITS

MB45 MILLING KITS

TURNING KITS

CUT-OFF KITS

	Pick 1 Cutter Part Number	Cutting Dia.	No. of Insert Pockets	Pick 1			Kit Part Number (Use when Ordering)	\$USD Kit Price	\$CAD Kit Price
				Insert Part Number	Material	Application			
09 Size (LOGU09 Inserts)	MA90-1500R-09T5C	1.500"	5	LOGU 090408ER-GM PR1825	Steel	General Purpose	THN08778KIT1825GM	\$450.00	\$630.00
				LOGU 090408ER-GH PR1810	Cast Iron		THN08778KIT1810GH		
				LOGU 090408ER-GH PR0155	Hardened Material		THN08778KIT0155GH		
				LOGU 090408ER-SM CA6535	Stainless Steel		THN08778KIT6535SM		
				LOGU 090408ER-SM PR1835			Stable Machining		
	MA90-1500R-09T6C	1.500"	6	LOGU 090408ER-GM PR1825	Steel	General Purpose	THN08779KIT1825GM	\$450.00	\$630.00
				LOGU 090408ER-GH PR1810	Cast Iron		THN08779KIT1810GH		
				LOGU 090408ER-GH PR0155	Hardened Material		THN08779KIT0155GH		
	MA90-2000R-09T6C	2.000"	6	LOGU 090408ER-SM CA6535	Stainless Steel	Wear Resistance	THN08779KIT6535SM	\$525.00	\$740.00
				LOGU 090408ER-SM PR1835			Stable Machining		
LOGU 090408ER-GM PR1825				Steel	General Purpose		THN08780KIT1825GM		
LOGU 090408ER-GH PR1810	Cast Iron	THN08780KIT1810GH							
LOGU 090408ER-GH PR0155	Hardened Material	THN08780KIT0155GH							
MA90-2000R-09T7C	2.000"	7	LOGU 090408ER-SM CA6535	Stainless Steel	Wear Resistance	THN08780KIT6535SM	\$525.00	\$740.00	
			LOGU 090408ER-SM PR1835			Stable Machining			THN08780KIT1835SM
			LOGU 090408ER-GM PR1825	Steel		General Purpose			THN08781KIT1825GM
LOGU 090408ER-GH PR1810	Cast Iron	THN08781KIT1810GH							
LOGU 090408ER-GH PR0155	Hardened Material	THN08781KIT0155GH							
MA90-2500R-09T7C	2.500"	7	LOGU 090408ER-SM CA6535	Stainless Steel	Wear Resistance	THN08781KIT6535SM	\$575.00	\$810.00	
			LOGU 090408ER-SM PR1835			Stable Machining			THN08781KIT1835SM
			LOGU 090408ER-GM PR1825	Steel		General Purpose			THN08782KIT1825GM
LOGU 090408ER-GH PR1810	Cast Iron	THN08782KIT1810GH							
LOGU 090408ER-GH PR0155	Hardened Material	THN08782KIT0155GH							
MA90-2500R-09T9C	2.500"	9	LOGU 090408ER-SM CA6535	Stainless Steel	Wear Resistance	THN08782KIT6535SM	\$575.00	\$810.00	
			LOGU 090408ER-SM PR1835			Stable Machining			THN08782KIT1835SM
			LOGU 090408ER-GM PR1825	Steel		General Purpose			THN08783KIT1825GM
LOGU 090408ER-GH PR1810	Cast Iron	THN08783KIT1810GH							
LOGU 090408ER-GH PR0155	Hardened Material	THN08783KIT0155GH							
12 Size (LOGU12 Inserts)	MA90-1500R-12T3C	1.500"	3	LOGU 120608ER-GM PR1825	Steel	General Purpose	THN08797KIT1825GM	\$450.00	\$630.00
				LOGU 120608ER-GH PR1810	Cast Iron		THN08797KIT1810GH		
				LOGU 120608ER-GH PR0155	Hardened Material		THN08797KIT0155GH		
				LOGU 120608ER-SM CA6535	Stainless Steel		THN08797KIT6535SM		
				LOGU 120608ER-SM PR1835			Stable Machining		
	MA90-1500R-12T4C	1.500"	4	LOGU 120608ER-GM PR1825	Steel	General Purpose	THN08798KIT1825GM	\$450.00	\$630.00
				LOGU 120608ER-GH PR1810	Cast Iron		THN08798KIT1810GH		
				LOGU 120608ER-GH PR0155	Hardened Material		THN08798KIT0155GH		
	MA90-2000R-12T4C	2.000"	4	LOGU 120608ER-SM CA6535	Stainless Steel	Wear Resistance	THN08798KIT6535SM	\$525.00	\$740.00
				LOGU 120608ER-SM PR1835			Stable Machining		
LOGU 120608ER-GM PR1825				Steel	General Purpose		THN08799KIT1825GM		
LOGU 120608ER-GH PR1810	Cast Iron	THN08799KIT1810GH							
LOGU 120608ER-GH PR0155	Hardened Material	THN08799KIT0155GH							
MA90-2000R-12T6C	2.000"	6	LOGU 120608ER-SM CA6535	Stainless Steel	Wear Resistance	THN08799KIT6535SM	\$525.00	\$740.00	
			LOGU 120608ER-SM PR1835			Stable Machining			THN08799KIT1835SM
			LOGU 120608ER-GM PR1825	Steel		General Purpose			THN08800KIT1825GM
LOGU 120608ER-GH PR1810	Cast Iron	THN08800KIT1810GH							
LOGU 120608ER-GH PR0155	Hardened Material	THN08800KIT0155GH							
MA90-2500R-12T6C	2.500"	6	LOGU 120608ER-SM CA6535	Stainless Steel	Wear Resistance	THN08800KIT6535SM	\$575.00	\$810.00	
			LOGU 120608ER-SM PR1835			Stable Machining			THN08800KIT1835SM
			LOGU 120608ER-GM PR1825	Steel		General Purpose			THN08801KIT1825GM
LOGU 120608ER-GH PR1810	Cast Iron	THN08801KIT1810GH							
LOGU 120608ER-GH PR0155	Hardened Material	THN08801KIT0155GH							
MA90-2500R-12T8C	2.500"	8	LOGU 120608ER-SM CA6535	Stainless Steel	Wear Resistance	THN08801KIT6535SM	\$575.00	\$810.00	
			LOGU 120608ER-SM PR1835			Stable Machining			THN08801KIT1835SM
			LOGU 120608ER-GM PR1825	Steel		General Purpose			THN08802KIT1825GM
LOGU 120608ER-GH PR1810	Cast Iron	THN08802KIT1810GH							
LOGU 120608ER-GH PR0155	Hardened Material	THN08802KIT0155GH							
MA90-3000R-12T8C	3.000"	8	LOGU 120608ER-SM CA6535	Stainless Steel	Wear Resistance	THN08802KIT6535SM	\$625.00	\$880.00	
			LOGU 120608ER-SM PR1835			Stable Machining			THN08802KIT1835SM
			LOGU 120608ER-GM PR1825	Steel		General Purpose			THN08803KIT1825GM
LOGU 120608ER-GH PR1810	Cast Iron	THN08803KIT1810GH							
LOGU 120608ER-GH PR0155	Hardened Material	THN08803KIT0155GH							
MA90-3000R-12T10C	3.000"	10	LOGU 120608ER-SM CA6535	Stainless Steel	Wear Resistance	THN08803KIT6535SM	\$625.00	\$880.00	
			LOGU 120608ER-SM PR1835			Stable Machining			THN08803KIT1835SM
			LOGU 120608ER-GM PR1825	Steel		General Purpose			THN08804KIT1825GM
LOGU 120608ER-GH PR1810	Cast Iron	THN08804KIT1810GH							
LOGU 120608ER-GH PR0155	Hardened Material	THN08804KIT0155GH							
				LOGU 120608ER-SM CA6535	Stainless Steel	Wear Resistance	THN08804KIT6535SM	\$625.00	\$880.00
				LOGU 120608ER-SM PR1835			Stable Machining		

2024 Fall - 2025 Winter Promo Pack Offers valid through March 31, 2025

All promotional items are available exclusively through Authorized North American KYOCERA Precision Tool Distributors.

Please use specified Promo Code or Kit Part Number when placing orders. To locate a distributor visit [www.kyoceraprecisiontools.com/locate](http://www.kyoceraprecisiontools.com/locate).

# MA90 Weldon Shank End Mill Kits

Includes (1) Cutter and (10) Inserts

Choose your Cutter, Insert Grade, and Chipbreaker



	Pick 1 Cutter Part Number	Cutting Dia.	No. of Insert Pockets	Pick 1			Kit Part Number (Use when Ordering)	\$USD Kit Price	\$CAD Kit Price
				Insert Part Number	Material	Application			
09 Size (LOGU09 Inserts)	MA90-0625-W625-09T2C	0.625"	2	LOGU 090408ER-GM PR1825	Steel	General Purpose	THN08764KIT1825GM	\$300.00	\$420.00
				LOGU 090408ER-GH PR1810	Cast Iron		THN08764KIT1810GH		
				LOGU 090408ER-GH PR0155	Hardened Material		THN08764KIT0155GH		
				LOGU 090408ER-SM CA6535	Stainless Steel		THN08764KIT6535SM		
	LOGU 090408ER-SM PR1835	THN08764KIT1835SM							
	MA90-0750-W750-09T3C	0.750"	3	LOGU 090408ER-GM PR1825	Steel	General Purpose	THN08765KIT1825GM	\$325.00	\$460.00
				LOGU 090408ER-GH PR1810	Cast Iron		THN08765KIT1810GH		
				LOGU 090408ER-GH PR0155	Hardened Material		THN08765KIT0155GH		
				LOGU 090408ER-SM CA6535	Stainless Steel		THN08765KIT6535SM		
	LOGU 090408ER-SM PR1835	THN08765KIT1835SM							
MA90-1000-W100-09T4C	1.000"	4	LOGU 090408ER-GM PR1825	Steel	General Purpose	THN08766KIT1825GM	\$375.00	\$530.00	
			LOGU 090408ER-GH PR1810	Cast Iron		THN08766KIT1810GH			
			LOGU 090408ER-GH PR0155	Hardened Material		THN08766KIT0155GH			
			LOGU 090408ER-SM CA6535	Stainless Steel		THN08766KIT6535SM			
LOGU 090408ER-SM PR1835	THN08766KIT1835SM								
MA90-1250-W100-09T4C	1.250"	4	LOGU 090408ER-GM PR1825	Steel	General Purpose	THN08767KIT1825GM	\$400.00	\$560.00	
			LOGU 090408ER-GH PR1810	Cast Iron		THN08767KIT1810GH			
			LOGU 090408ER-GH PR0155	Hardened Material		THN08767KIT0155GH			
			LOGU 090408ER-SM CA6535	Stainless Steel		THN08767KIT6535SM			
LOGU 090408ER-SM PR1835	THN08767KIT1835SM								
MA90-1250-W100-09T5C	1.250"	5	LOGU 090408ER-GM PR1825	Steel	General Purpose	THN08768KIT1825GM	\$400.00	\$560.00	
			LOGU 090408ER-GH PR1810	Cast Iron		THN08768KIT1810GH			
			LOGU 090408ER-GH PR0155	Hardened Material		THN08768KIT0155GH			
			LOGU 090408ER-SM CA6535	Stainless Steel		THN08768KIT6535SM			
LOGU 090408ER-SM PR1835	THN08768KIT1835SM								
MA90-1250-W125-09T5C	1.250"	5	LOGU 090408ER-GM PR1825	Steel	General Purpose	THN08769KIT1825GM	\$425.00	\$600.00	
			LOGU 090408ER-GH PR1810	Cast Iron		THN08769KIT1810GH			
			LOGU 090408ER-GH PR0155	Hardened Material		THN08769KIT0155GH			
			LOGU 090408ER-SM CA6535	Stainless Steel		THN08769KIT6535SM			
LOGU 090408ER-SM PR1835	THN08769KIT1835SM								
MA90-1500-W125-09T5C	1.500"	5	LOGU 090408ER-GM PR1825	Steel	General Purpose	THN08770KIT1825GM	\$450.00	\$630.00	
			LOGU 090408ER-GH PR1810	Cast Iron		THN08770KIT1810GH			
			LOGU 090408ER-GH PR0155	Hardened Material		THN08770KIT0155GH			
			LOGU 090408ER-SM CA6535	Stainless Steel		THN08770KIT6535SM			
LOGU 090408ER-SM PR1835	THN08770KIT1835SM								
MA90-1500-W125-09T6C	1.500"	6	LOGU 090408ER-GM PR1825	Steel	General Purpose	THN08771KIT1825GM	\$450.00	\$630.00	
			LOGU 090408ER-GH PR1810	Cast Iron		THN08771KIT1810GH			
			LOGU 090408ER-GH PR0155	Hardened Material		THN08771KIT0155GH			
			LOGU 090408ER-SM CA6535	Stainless Steel		THN08771KIT6535SM			
LOGU 090408ER-SM PR1835	THN08771KIT1835SM								
12 Size (LOGU12 Inserts)	MA90-1000-W100-12T2C	1.000"	2	LOGU 120608ER-GM PR1825	Steel	General Purpose	THN08787KIT1825GM	\$350.00	\$490.00
				LOGU 120608ER-GH PR1810	Cast Iron		THN08787KIT1810GH		
				LOGU 120608ER-GH PR0155	Hardened Material		THN08787KIT0155GH		
				LOGU 120608ER-SM CA6535	Stainless Steel		THN08787KIT6535SM		
	LOGU 120608ER-SM PR1835	THN08787KIT1835SM							
	MA90-1250-W100-12T2C	1.250"	2	LOGU 120608ER-GM PR1825	Steel	General Purpose	THN08788KIT1825GM	\$400.00	\$560.00
				LOGU 120608ER-GH PR1810	Cast Iron		THN08788KIT1810GH		
				LOGU 120608ER-GH PR0155	Hardened Material		THN08788KIT0155GH		
				LOGU 120608ER-SM CA6535	Stainless Steel		THN08788KIT6535SM		
	LOGU 120608ER-SM PR1835	THN08788KIT1835SM							
MA90-1250-W100-12T3C	1.250"	3	LOGU 120608ER-GM PR1825	Steel	General Purpose	THN08789KIT1825GM	\$400.00	\$560.00	
			LOGU 120608ER-GH PR1810	Cast Iron		THN08789KIT1810GH			
			LOGU 120608ER-GH PR0155	Hardened Material		THN08789KIT0155GH			
			LOGU 120608ER-SM CA6535	Stainless Steel		THN08789KIT6535SM			
LOGU 120608ER-SM PR1835	THN08789KIT1835SM								
MA90-1250-W125-12T3C	1.250"	3	LOGU 120608ER-GM PR1825	Steel	General Purpose	THN08790KIT1825GM	\$400.00	\$560.00	
			LOGU 120608ER-GH PR1810	Cast Iron		THN08790KIT1810GH			
			LOGU 120608ER-GH PR0155	Hardened Material		THN08790KIT0155GH			
			LOGU 120608ER-SM CA6535	Stainless Steel		THN08790KIT6535SM			
LOGU 120608ER-SM PR1835	THN08790KIT1835SM								
MA90-1500-W125-12T3C	1.500"	3	LOGU 120608ER-GM PR1825	Steel	General Purpose	THN08791KIT1825GM	\$425.00	\$600.00	
			LOGU 120608ER-GH PR1810	Cast Iron		THN08791KIT1810GH			
			LOGU 120608ER-GH PR0155	Hardened Material		THN08791KIT0155GH			
			LOGU 120608ER-SM CA6535	Stainless Steel		THN08791KIT6535SM			
LOGU 120608ER-SM PR1835	THN08791KIT1835SM								
MA90-1500-W125-12T4C	1.500"	4	LOGU 120608ER-GM PR1825	Steel	General Purpose	THN08792KIT1825GM	\$450.00	\$630.00	
			LOGU 120608ER-GH PR1810	Cast Iron		THN08792KIT1810GH			
			LOGU 120608ER-GH PR0155	Hardened Material		THN08792KIT0155GH			
			LOGU 120608ER-SM CA6535	Stainless Steel		THN08792KIT6535SM			
LOGU 120608ER-SM PR1835	THN08792KIT1835SM								

MA90 MILLING KITS

MB45 MILLING KITS

TURNING KITS

CUT-OFF KITS



# MA90 Straight Shank End Mill Kits

Includes (1) Cutter and (10) Inserts

Choose your Cutter, Insert Grade, and Chipbreaker



MA90 MILLING KITS

MB45 MILLING KITS

TURNING KITS

CUT-OFF KITS

	Pick 1 Cutter Part Number	Cutting Dia.	No. of Insert Pockets	Pick 1			Kit Part Number (Use when Ordering)	\$USD Kit Price	\$CAD Kit Price		
				Insert Part Number	Material	Application					
Straight - Standard Shank	09 Size (LOGU09 Inserts)	MA90-0625-S625-09T2C	0.625"	2	LOGU 090408ER-GM PR1825	Steel	General Purpose	THN08759KIT1825GM	\$300.00	\$420.00	
					LOGU 090408ER-GH PR1810	Cast Iron		THN08759KIT1810GH			
					LOGU 090408ER-GH PR0155	Hardened Material		THN08759KIT0155GH			
					LOGU 090408ER-SM CA6535	Stainless Steel		Wear Resistance			THN08759KIT6535SM
					LOGU 090408ER-SM PR1835			Stable Machining			THN08759KIT1835SM
	MA90-0750-S750-09T3C	0.750"	3	LOGU 090408ER-GM PR1825	Steel	General Purpose	THN08760KIT1825GM	\$325.00	\$460.00		
				LOGU 090408ER-GH PR1810	Cast Iron		THN08760KIT1810GH				
				LOGU 090408ER-GH PR0155	Hardened Material		THN08760KIT0155GH				
				LOGU 090408ER-SM CA6535	Stainless Steel		Wear Resistance			THN08760KIT6535SM	
				LOGU 090408ER-SM PR1835			Stable Machining			THN08760KIT1835SM	
MA90-1000-S100-09T4C	1.000"	4	LOGU 090408ER-GM PR1825	Steel	General Purpose	THN08761KIT1825GM	\$375.00	\$530.00			
			LOGU 090408ER-GH PR1810	Cast Iron		THN08761KIT1810GH					
			LOGU 090408ER-GH PR0155	Hardened Material		THN08761KIT0155GH					
			LOGU 090408ER-SM CA6535	Stainless Steel		Wear Resistance			THN08761KIT6535SM		
			LOGU 090408ER-SM PR1835			Stable Machining			THN08761KIT1835SM		
MA90-1250-S100-09T5C	1.250"	5	LOGU 090408ER-GM PR1825	Steel	General Purpose	THN08762KIT1825GM	\$425.00	\$600.00			
			LOGU 090408ER-GH PR1810	Cast Iron		THN08762KIT1810GH					
			LOGU 090408ER-GH PR0155	Hardened Material		THN08762KIT0155GH					
			LOGU 090408ER-SM CA6535	Stainless Steel		Wear Resistance			THN08762KIT6535SM		
			LOGU 090408ER-SM PR1835			Stable Machining			THN08762KIT1835SM		
MA90-1500-S125-09T5C	1.500"	5	LOGU 090408ER-GM PR1825	Steel	General Purpose	THN08763KIT1825GM	\$450.00	\$630.00			
			LOGU 090408ER-GH PR1810	Cast Iron		THN08763KIT1810GH					
			LOGU 090408ER-GH PR0155	Hardened Material		THN08763KIT0155GH					
			LOGU 090408ER-SM CA6535	Stainless Steel		Wear Resistance			THN08763KIT6535SM		
			LOGU 090408ER-SM PR1835			Stable Machining			THN08763KIT1835SM		
12 Size (LOGU12 Inserts)	MA90-1000-S100-12T2C	1.000"	2	LOGU 120608ER-GM PR1825	Steel	General Purpose	THN08784KIT1825GM	\$350.00	\$490.00		
				LOGU 120608ER-GH PR1810	Cast Iron		THN08784KIT1810GH				
				LOGU 120608ER-GH PR0155	Hardened Material		THN08784KIT0155GH				
	MA90-1250-S100-12T3C	1.250"	3	LOGU 120608ER-SM CA6535	Stainless Steel	Wear Resistance	THN08784KIT6535SM	\$400.00	\$260.00		
				LOGU 120608ER-SM PR1835		Stable Machining	THN08784KIT1835SM				
				LOGU 120608ER-GM PR1825	Steel	General Purpose	THN08785KIT1825GM				
	LOGU 120608ER-GH PR1810	Cast Iron	THN08785KIT1810GH								
	LOGU 120608ER-GH PR0155	Hardened Material	THN08785KIT0155GH								
	MA90-1500-S125-12T4C	1.500"	4	LOGU 120608ER-SM CA6535	Stainless Steel	Wear Resistance	THN08786KIT6535SM	\$450.00	\$630.00		
LOGU 120608ER-SM PR1835				Stable Machining		THN08786KIT1835SM					
LOGU 120608ER-GM PR1825				Steel	General Purpose	THN08786KIT1825GM					
LOGU 120608ER-GH PR1810	Cast Iron	THN08786KIT1810GH									
LOGU 120608ER-GH PR0155	Hardened Material	THN08786KIT0155GH									
Straight - Long Shank	09 Size (LOGU09 Inserts)	MA90-0750-S750-09T3CL	0.750"	3	LOGU 090408ER-GM PR1825	Steel	General Purpose	THN08772KIT1825GM	\$350.00	\$490.00	
					LOGU 090408ER-GH PR1810	Cast Iron		THN08772KIT1810GH			
					LOGU 090408ER-GH PR0155	Hardened Material		THN08772KIT0155GH			
					LOGU 090408ER-SM CA6535	Stainless Steel		Wear Resistance			THN08772KIT6535SM
					LOGU 090408ER-SM PR1835			Stable Machining			THN08772KIT1835SM
	MA90-1000-S100-09T3CL	1.000"	3	LOGU 090408ER-GM PR1825	Steel	General Purpose	THN08773KIT1825GM	\$375.00	\$530.00		
				LOGU 090408ER-GH PR1810	Cast Iron		THN08773KIT1810GH				
				LOGU 090408ER-GH PR0155	Hardened Material		THN08773KIT0155GH				
				LOGU 090408ER-SM CA6535	Stainless Steel		Wear Resistance			THN08773KIT6535SM	
				LOGU 090408ER-SM PR1835			Stable Machining			THN08773KIT1835SM	
MA90-1500-S125-09T3CL	1.500"	3	LOGU 090408ER-GM PR1825	Steel	General Purpose	THN08774KIT1825GM	\$425.00	\$600.00			
			LOGU 090408ER-GH PR1810	Cast Iron		THN08774KIT1810GH					
			LOGU 090408ER-GH PR0155	Hardened Material		THN08774KIT0155GH					
			LOGU 090408ER-SM CA6535	Stainless Steel		Wear Resistance			THN08774KIT6535SM		
			LOGU 090408ER-SM PR1835			Stable Machining			THN08774KIT1835SM		
12 Size (LOGU12 Inserts)	MA90-1000-S100-12T2CL	1.000"	2	LOGU 120608ER-GM PR1825	Steel	General Purpose	THN08793KIT1825GM	\$375.00	\$530.00		
				LOGU 120608ER-GH PR1810	Cast Iron		THN08793KIT1810GH				
				LOGU 120608ER-GH PR0155	Hardened Material		THN08793KIT0155GH				
	MA90-1500-S125-12T3CL	1.500"	3	LOGU 120608ER-SM CA6535	Stainless Steel	Wear Resistance	THN08793KIT6535SM	\$450.00	\$630.00		
				LOGU 120608ER-SM PR1835		Stable Machining	THN08793KIT1835SM				
LOGU 120608ER-GM PR1825	Steel	General Purpose	THN08794KIT1825GM								
LOGU 120608ER-GH PR1810	Cast Iron		THN08794KIT1810GH								
LOGU 120608ER-GH PR0155	Hardened Material		THN08794KIT0155GH								

2024 Fall - 2025 Winter Promo Pack Offers valid through March 31, 2025

All promotional items are available exclusively through Authorized North American KYOCERA Precision Tool Distributors.

Please use specified Promo Code or Kit Part Number when placing orders. To locate a distributor visit [www.kyoceraprecisiontools.com/locate](http://www.kyoceraprecisiontools.com/locate).



# MA90 Modular End Mill Kits

Includes (1) Cutter and (10) Inserts

Choose your Cutter, Insert Grade, and Chipbreaker



Pick 1	Cutter Part Number	Cutting Dia.	No. of Insert Pockets	Pick 1			Kit Part Number (Use when Ordering)	\$USD Kit Price	\$CAD Kit Price
				Insert Part Number	Material	Application			
09 Size (LOGU09 Inserts)	MA90-0750M10-09T3C	0.750"	3	LOGU 090408ER-GM PR1825	Steel	General Purpose	THN08775KIT1825GM	\$325.00	\$460.00
				LOGU 090408ER-GH PR1810	Cast Iron		THN08775KIT1810GH		
				LOGU 090408ER-GH PR0155	Hardened Material		THN08775KIT0155GH		
				LOGU 090408ER-SM CA6535	Stainless Steel		THN08775KIT6535SM		
	LOGU 090408ER-SM PR1835	THN08775KIT1835SM							
	MA90-1000M12-09T4C	1.000"	4	LOGU 090408ER-GM PR1825	Steel	General Purpose	THN08776KIT1825GM	\$375.00	\$530.00
				LOGU 090408ER-GH PR1810	Cast Iron		THN08776KIT1810GH		
				LOGU 090408ER-SM CA6535	Stainless Steel		THN08776KIT0155GH		
				LOGU 090408ER-SM PR1835			THN08776KIT6535SM		
	MA90-1250M16-09T5C	1.250"	5	LOGU 090408ER-GM PR1825	Steel	General Purpose	THN08776KIT1825GM	\$400.00	\$560.00
				LOGU 090408ER-GH PR1810	Cast Iron		THN08777KIT1810GH		
				LOGU 090408ER-SM CA6535	Stainless Steel		THN08777KIT0155GH		
LOGU 090408ER-SM PR1835				THN08777KIT1835SM					
12 Size (LOGU12 Inserts)	MA90-1000M12-12T2C	1.000"	2	LOGU 120608ER-GM PR1825	Steel	General Purpose	THN08795KIT1825GM	\$325.00	\$460.00
				LOGU 120608ER-GH PR1810	Cast Iron		THN08795KIT1810GH		
				LOGU 120608ER-GH PR0155	Hardened Material		THN08795KIT0155GH		
				LOGU 120608ER-SM CA6535	Stainless Steel		THN08795KIT6535SM		
	LOGU 120608ER-SM PR1835	THN08795KIT1835SM							
	MA90-1250M16-12T3C	1.250"	3	LOGU 120608ER-GM PR1825	Steel	General Purpose	THN08796KIT1825GM	\$375.00	\$530.00
				LOGU 120608ER-GH PR1810	Cast Iron		THN08796KIT1810GH		
				LOGU 120608ER-GH PR0155	Hardened Material		THN08796KIT0155GH		
				LOGU 120608ER-SM CA6535	Stainless Steel		THN08796KIT6535SM		
	LOGU 120608ER-SM PR1835	THN08796KIT1835SM							

## Applicable Inserts

Shape	Description	Usage Classification						Dimensions (in)				MEGACOAT NANO EX (PVD Coating)		CVD Coating				
		P	M	K	S	H	RE	S	D1	INSL	BS	PR1825	PR1835	PR1810	PR0155	CA6535		
																	W1	S
<p>Unmarked : GM △ : SM □ : GH</p>	LOGU 090408ER-GM	★									●							
	LOGU 090408ER-SM						0.169	0.264	0.131	0.350	0.035	0.031		●			●	
	LOGU 090408ER-GH													●	●		-	
	LOGU 120608ER-GM													●				
	LOGU 120608ER-SM							0.260	0.395	0.179	0.523	0.084	0.031		●			●
	LOGU 120608ER-GH														●	●		-

See [MA90 Brochure](#) for other available insert sizes and grades

● : Available in Promo Kits

# MB45

45° General Purpose Milling Series



View Online



Product Video



Product Brochure

Provides high quality and high performance machining solutions with long tool life

Delivers the low cutting force benefits of positive inserts and the fracture resistance benefits of negative inserts, and provides excellent surface finish

## Extreme versatility

General-purpose milling cutters must strike a balance between quality, performance, long tool life, economy, and versatility to effectively handle a wide range of machining tasks.

The MB45 achieves all these qualities without compromise. These next-generation cutters are durable, ensuring reliability whether used for general machining applications or for discovering innovative machining solutions.

MA90 MILLING KITS

MB45 MILLING KITS

TURNING KITS

CUT-OFF KITS

01

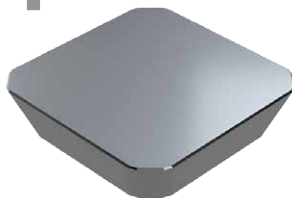

ISO Standard SEKN Type  
(No breaker)

02



Positive (Single-sided) Type

Advantage

- Low cutting force
- Excellent finished surface and machining accuracy

03



Negative (Double-sided) Type

Advantage

- Excellent fracture resistance
- Economical with multiple cutting edges

2024 Fall - 2025 Winter Promo Pack Offers valid through March 31, 2025

All promotional items are available exclusively through Authorized North American KYOCERA Precision Tool Distributors.

Please use specified Promo Code or Kit Part Number when placing orders. To locate a distributor visit [www.kyoceraprecisiontools.com/locate](http://www.kyoceraprecisiontools.com/locate).



MA90 MILLING KITS

MB45 MILLING KITS

TURNING KITS

CUT-OFF KITS

04

# MB45

Delivers the “low cutting force” benefits of positive inserts and the “fracture resistance” benefits of negative inserts

## High Quality

High quality results and excellent surface finish

- Lineup of E class inserts
- Long arc wiper edge
- Back coolant hole

## High Performance

Unique low cutting force design with fracture resistance

- Double edge structure and helical cutting edge (A.R. max + 13°)

## Long Tool Life

Next-generation PVD coating for milling PR18 Series **NEW**

- Double lamination technology maintains longer tool life
- Double-sided 8-edge design reduces tool costs

## Solution

Find new value with excellent versatility

- Integrated tooling: Roughing and finishing with E class inserts
- For a wide variety of machining applications: Small machines (BT30, etc.) with ø40mm cutter
- For a variety of workpieces: Cost-cutting with multiple cutting edges for aluminum machining
- Enhanced Quality: Gain excellent surface finish with Cermet inserts (TN620M)



## MB45 Coarse Pitch Face Mill Kits

Includes (1) Cutter and (10) Inserts

Choose your Cutter, Insert Grade, and Chipbreaker



Cutter Part Number	Cutting Dia.	No. of Insert Pockets	Pick 1			Kit Part Number (Use when Ordering)	\$USD Kit Price	\$CAD Kit Price
			Insert Part Number	Material	Application			
MB45--200R--14T3C	2.000"	3	SNMU 1406ANER-GM PR1825	Steel	General Purpose	THN08901KITM1825GM	\$400.00	\$560.00
			SNEU 1406ANER-GM PR1825		Good Surface Finish	THN08901KITE1825GM		
			SNEU 1406ANER-SM PR1835	Stainless Steel	Stable Machining	THN08901KITE1835SM		
			SNEU 1406ANER-SM CA6535		Wear Resistance	THN08901KITE6535SM		
			SNMU 1406ANER-GH PR1810	Cast Iron	General Purpose	THN08901KITM1810GH		
			SNMU 1406ANER-GH PR0155	Hardened Material	General Purpose	THN08901KITM0155GH		
			SNEU 1406ANER-AM PDL025	Non-Ferrous	General Purpose	THN08901KITELO25AM		
MB45-2500R-14T4C	2.500"	4	SNMU 1406ANER-GM PR1825	Steel	General Purpose	THN08902KITM1825GM	\$500.00	\$700.00
			SNEU 1406ANER-GM PR1825		Good Surface Finish	THN08902KITE1825GM		
			SNEU 1406ANER-SM PR1835	Stainless Steel	Stable Machining	THN08902KITE1835SM		
			SNEU 1406ANER-SM CA6535		Wear Resistance	THN08902KITE6535SM		
			SNMU 1406ANER-GH PR1810	Cast Iron	General Purpose	THN08902KITM1810GH		
			SNMU 1406ANER-GH PR0155	Hardened Material	General Purpose	THN08902KITM0155GH		
			SNEU 1406ANER-AM PDL025	Non-Ferrous	General Purpose	THN08902KITELO25AM		
MB45-3000R-14T5C	3.000"	5	SNMU 1406ANER-GM PR1825	Steel	General Purpose	THN08903KITM1825GM	\$550.00	\$770.00
			SNEU 1406ANER-GM PR1825		Good Surface Finish	THN08903KITE1825GM		
			SNEU 1406ANER-SM PR1835	Stainless Steel	Stable Machining	THN08903KITE1835SM		
			SNEU 1406ANER-SM CA6535		Wear Resistance	THN08903KITE6535SM		
			SNMU 1406ANER-GH PR1810	Cast Iron	General Purpose	THN08903KITM1810GH		
			SNMU 1406ANER-GH PR0155	Hardened Material	General Purpose	THN08903KITM0155GH		
			SNEU 1406ANER-AM PDL025	Non-Ferrous	General Purpose	THN08903KITELO25AM		
MB45-4000R-14T5C	4.000"	5	SNMU 1406ANER-GM PR1825	Steel	General Purpose	THN08904KITM1825GM	\$600.00	\$840.00
			SNEU 1406ANER-GM PR1825		Good Surface Finish	THN08904KITE1825GM		
			SNEU 1406ANER-SM PR1835	Stainless Steel	Stable Machining	THN08904KITE1835SM		
			SNEU 1406ANER-SM CA6535		Wear Resistance	THN08904KITE6535SM		
			SNMU 1406ANER-GH PR1810	Cast Iron	General Purpose	THN08904KITM1810GH		
			SNMU 1406ANER-GH PR0155	Hardened Material	General Purpose	THN08904KITM0155GH		
			SNEU 1406ANER-AM PDL025	Non-Ferrous	General Purpose	THN08904KITELO25AM		
MB45-5000R-14T6C	5.000"	6	SNMU 1406ANER-GM PR1825	Steel	General Purpose	THN08905KITM1825GM	\$700.00	\$980.00
			SNEU 1406ANER-GM PR1825		Good Surface Finish	THN08905KITE1825GM		
			SNEU 1406ANER-SM PR1835	Stainless Steel	Stable Machining	THN08905KITE1835SM		
			SNEU 1406ANER-SM CA6535		Wear Resistance	THN08905KITE6535SM		
			SNMU 1406ANER-GH PR1810	Cast Iron	General Purpose	THN08905KITM1810GH		
			SNMU 1406ANER-GH PR0155	Hardened Material	General Purpose	THN08905KITM0155GH		
			SNEU 1406ANER-AM PDL025	Non-Ferrous	General Purpose	THN08905KITELO25AM		

Coarse Pitch Face Mills

MA90 MILLING KITS

MB45 MILLING KITS

TURNING KITS

CUT-OFF KITS

2024 Fall - 2025 Winter Promo Pack Offers valid through March 31, 2025

All promotional items are available exclusively through Authorized North American KYOCERA Precision Tool Distributors.

Please use specified Promo Code or Kit Part Number when placing orders. To locate a distributor visit [www.kyoceraprecisiontools.com/locate](http://www.kyoceraprecisiontools.com/locate).

# MB45 Fine Pitch Face Mill Kits

Includes (1) Cutter and (10) Inserts

Choose your Cutter, Insert Grade, and Chipbreaker



	Pick 1 Cutter Part Number	Cutting Dia.	No. of Insert Pockets	Pick 1			Kit Part Number (Use when Ordering)	\$USD Kit Price	\$CAD Kit Price
				Insert Part Number	Material	Application			
Fine Pitch Face Mills	MB45-2000R-14T4C	2.000"	4	SNMU 1406ANER-GM PR1825	Steel	General Purpose	THN08907KITM1825GM	\$400.00	\$560.00
				SNEU 1406ANER-GM PR1825		Good Surface Finish	THN08907KITE1825GM		
				SNEU 1406ANER-SM PR1835	Stainless Steel	Stable Machining	THN08907KITE1835SM		
				SNEU 1406ANER-SM CA6535		Wear Resistance	THN08907KITE6535SM		
				SNMU 1406ANER-GH PR1810	Cast Iron	General Purpose	THN08907KITM1810GH		
				SNMU 1406ANER-GH PR0155	Hardened Material	General Purpose	THN08907KITM0155GH		
				SNEU 1406ANER-AM PDL025	Non-Ferrous	General Purpose	THN08907KITEL025AM		
	MB45-2500R-14T5C	2.500"	5	SNMU 1406ANER-GM PR1825	Steel	General Purpose	THN08908KITM1825GM	\$500.00	\$700.00
				SNEU 1406ANER-GM PR1825		Good Surface Finish	THN08908KITE1825GM		
				SNEU 1406ANER-SM PR1835	Stainless Steel	Stable Machining	THN08908KITE1835SM		
				SNEU 1406ANER-SM CA6535		Wear Resistance	THN08908KITE6535SM		
				SNMU 1406ANER-GH PR1810	Cast Iron	General Purpose	THN08908KITM1810GH		
				SNMU 1406ANER-GH PR0155	Hardened Material	General Purpose	THN08908KITM0155GH		
				SNEU 1406ANER-AM PDL025	Non-Ferrous	General Purpose	THN08908KITEL025AM		
	MB45-3000R-14T6C	3.000"	6	SNMU 1406ANER-GM PR1825	Steel	General Purpose	THN08909KITM1825GM	\$550.00	\$770.00
				SNEU 1406ANER-GM PR1825		Good Surface Finish	THN08909KITE1825GM		
				SNEU 1406ANER-SM PR1835	Stainless Steel	Stable Machining	THN08909KITE1835SM		
				SNEU 1406ANER-SM CA6535		Wear Resistance	THN08909KITE6535SM		
				SNMU 1406ANER-GH PR1810	Cast Iron	General Purpose	THN08909KITM1810GH		
				SNMU 1406ANER-GH PR0155	Hardened Material	General Purpose	THN08909KITM0155GH		
				SNEU 1406ANER-AM PDL025	Non-Ferrous	General Purpose	THN08909KITEL025AM		
	MB45-4000R-14T8C	4.000"	8	SNMU 1406ANER-GM PR1825	Steel	General Purpose	THN08910KITM1825GM	\$700.00	\$980.00
				SNEU 1406ANER-GM PR1825		Good Surface Finish	THN08910KITE1825GM		
				SNEU 1406ANER-SM PR1835	Stainless Steel	Stable Machining	THN08910KITE1835SM		
				SNEU 1406ANER-SM CA6535		Wear Resistance	THN08910KITE6535SM		
				SNMU 1406ANER-GH PR1810	Cast Iron	General Purpose	THN08910KITM1810GH		
				SNMU 1406ANER-GH PR0155	Hardened Material	General Purpose	THN08910KITM0155GH		
				SNEU 1406ANER-AM PDL025	Non-Ferrous	General Purpose	THN08910KITEL025AM		
MB45-5000R-14T10C	5.000"	10	SNMU 1406ANER-GM PR1825	Steel	General Purpose	THN08911KITM1825GM	\$800.00	\$1,120.00	
			SNEU 1406ANER-GM PR1825		Good Surface Finish	THN08911KITE1825GM			
			SNEU 1406ANER-SM PR1835	Stainless Steel	Stable Machining	THN08911KITE1835SM			
			SNEU 1406ANER-SM CA6535		Wear Resistance	THN08911KITE6535SM			
			SNMU 1406ANER-GH PR1810	Cast Iron	General Purpose	THN08911KITM1810GH			
			SNMU 1406ANER-GH PR0155	Hardened Material	General Purpose	THN08911KITM0155GH			
			SNEU 1406ANER-AM PDL025	Non-Ferrous	General Purpose	THN08911KITEL025AM			

MA90 MILLING KITS  
MB45 MILLING KITS  
TURNING KITS  
CUT-OFF KITS

## MB45 Extra Fine Pitch Face Mill Kits

Includes (1) Cutter and (10) Inserts

Choose your Cutter, Insert Grade, and Chipbreaker



	Pick 1 Cutter Part Number	Cutting Dia.	No. of Insert Pockets	Pick 1			Kit Part Number (Use when Ordering)	\$USD Kit Price	\$CAD Kit Price
				Insert Part Number	Material	Application			
Extra Fine Pitch Face Mills	MB45-2000R-14T5C	2.000"	5	SNMU 1406ANER-GM PR1825	Steel	General Purpose	THN08913KITM1825GM	\$500.00	\$700.00
				SNEU 1406ANER-GM PR1825		Good Surface Finish	THN08913KITE1825GM		
				SNEU 1406ANER-SM PR1835	Stainless Steel	Stable Machining	THN08913KITE1835SM		
				SNEU 1406ANER-SM CA6535		Wear Resistance	THN08913KITE6535SM		
				SNMU 1406ANER-GH PR1810	Cast Iron	General Purpose	THN08913KITM1810GH		
				SNMU 1406ANER-GH PR0155	Hardened Material	General Purpose	THN08913KITM0155GH		
				SNEU 1406ANER-AM PDL025	Non-Ferrous	General Purpose	THN08913KITELO25AM		
	MB45-2500R-14T6C	2.500"	6	SNMU 1406ANER-GM PR1825	Steel	General Purpose	THN08914KITM1825GM	\$550.00	\$770.00
				SNEU 1406ANER-GM PR1825		Good Surface Finish	THN08914KITE1825GM		
				SNEU 1406ANER-SM PR1835	Stainless Steel	Stable Machining	THN08914KITE1835SM		
				SNEU 1406ANER-SM CA6535		Wear Resistance	THN08914KITE6535SM		
				SNMU 1406ANER-GH PR1810	Cast Iron	General Purpose	THN08914KITM1810GH		
				SNMU 1406ANER-GH PR0155	Hardened Material	General Purpose	THN08914KITM0155GH		
				SNEU 1406ANER-AM PDL025	Non-Ferrous	General Purpose	THN08914KITELO25AM		
	MB45-3000R-14T8C	3.000"	8	SNMU 1406ANER-GM PR1825	Steel	General Purpose	THN08915KITM1825GM	\$600.00	\$840.00
				SNEU 1406ANER-GM PR1825		Good Surface Finish	THN08915KITE1825GM		
				SNEU 1406ANER-SM PR1835	Stainless Steel	Stable Machining	THN08915KITE1835SM		
				SNEU 1406ANER-SM CA6535		Wear Resistance	THN08915KITE6535SM		
				SNMU 1406ANER-GH PR1810	Cast Iron	General Purpose	THN08915KITM1810GH		
				SNMU 1406ANER-GH PR0155	Hardened Material	General Purpose	THN08915KITM0155GH		
				SNEU 1406ANER-AM PDL025	Non-Ferrous	General Purpose	THN08915KITELO25AM		
	MB45-4000R-14T10C	4.000"	10	SNMU 1406ANER-GM PR1825	Steel	General Purpose	THN08916KITM1825GM	\$800.00	\$1,120.00
				SNEU 1406ANER-GM PR1825		Good Surface Finish	THN08916KITE1825GM		
				SNEU 1406ANER-SM PR1835	Stainless Steel	Stable Machining	THN08916KITE1835SM		
				SNEU 1406ANER-SM CA6535		Wear Resistance	THN08916KITE6535SM		
				SNMU 1406ANER-GH PR1810	Cast Iron	General Purpose	THN08916KITM1810GH		
				SNMU 1406ANER-GH PR0155	Hardened Material	General Purpose	THN08916KITM0155GH		
				SNEU 1406ANER-AM PDL025	Non-Ferrous	General Purpose	THN08916KITELO25AM		

2024 Fall - 2025 Winter Promo Pack Offers valid through March 31, 2025

All promotional items are available exclusively through Authorized North American KYOCERA Precision Tool Distributors.

Please use specified Promo Code or Kit Part Number when placing orders. To locate a distributor visit [www.kyoceraprecisiontools.com/locate](http://www.kyoceraprecisiontools.com/locate).

MA90 MILLING KITS

MB45 MILLING KITS

TURNING KITS

CUT-OFF KITS



# MB45 End Mill Kits

Includes (1) Cutter and (10) Inserts

Choose your Cutter, Insert Grade, and Chipbreaker



	Pick 1 Cutter Part Number	Cutting Dia.	No. of Insert Pockets	Pick 1			Kit Part Number (Use when Ordering)	\$USD Kit Price	\$CAD Kit Price
				Insert Part Number	Material	Application			
End Mills	MB45-1500-S125-14T2C	1.500"	2	SNMU 1406ANER-GM PR1825	Steel	General Purpose	THN08918KITM1825GM	\$350.00	\$490.00
				SNEU 1406ANER-GM PR1825		Good Surface Finish	THN08918KITE1825GM		
				SNEU 1406ANER-SM PR1835	Stainless Steel	Stable Machining	THN08918KITE1835SM		
				SNEU 1406ANER-SM CA6535		Wear Resistance	THN08918KITE6535SM		
				SNMU 1406ANER-GH PR1810	Cast Iron	General Purpose	THN08918KITM1810GH		
				SNMU 1406ANER-GH PR0155	Hardened Material	General Purpose	THN08918KITM0155GH		
				SNEU 1406ANER-AM PDL025	Non-Ferrous	General Purpose	THN08918KITEL025AM		
	MB45-1500-S125-14T3C	1.500"	3	SNMU 1406ANER-GM PR1825	Steel	General Purpose	THN08919KITM1825GM	\$350.00	\$490.00
				SNEU 1406ANER-GM PR1825		Good Surface Finish	THN08919KITE1825GM		
				SNEU 1406ANER-SM PR1835	Stainless Steel	Stable Machining	THN08919KITE1835SM		
				SNEU 1406ANER-SM CA6535		Wear Resistance	THN08919KITE6535SM		
				SNMU 1406ANER-GH PR1810	Cast Iron	General Purpose	THN08919KITM1810GH		
				SNMU 1406ANER-GH PR0155	Hardened Material	General Purpose	THN08919KITM0155GH		
				SNEU 1406ANER-AM PDL025	Non-Ferrous	General Purpose	THN08919KITEL025AM		
	MB45-2000-S125-14T3C	2.000"	3	SNMU 1406ANER-GM PR1825	Steel	General Purpose	THN08920KITM1825GM	\$400.00	\$560.00
				SNEU 1406ANER-GM PR1825		Good Surface Finish	THN08920KITE1825GM		
				SNEU 1406ANER-SM PR1835	Stainless Steel	Stable Machining	THN08920KITE1835SM		
				SNEU 1406ANER-SM CA6535		Wear Resistance	THN08920KITE6535SM		
				SNMU 1406ANER-GH PR1810	Cast Iron	General Purpose	THN08920KITM1810GH		
				SNMU 1406ANER-GH PR0155	Hardened Material	General Purpose	THN08920KITM0155GH		
				SNEU 1406ANER-AM PDL025	Non-Ferrous	General Purpose	THN08920KITEL025AM		
	MB45-2500-S125-14T4C	2.500"	4	SNMU 1406ANER-GM PR1825	Steel	General Purpose	THN08921KITM1825GM	\$450.00	\$630.00
				SNEU 1406ANER-GM PR1825		Good Surface Finish	THN08921KITE1825GM		
				SNEU 1406ANER-SM PR1835	Stainless Steel	Stable Machining	THN08921KITE1835SM		
				SNEU 1406ANER-SM CA6535		Wear Resistance	THN08921KITE6535SM		
				SNMU 1406ANER-GH PR1810	Cast Iron	General Purpose	THN08921KITM1810GH		
				SNMU 1406ANER-GH PR0155	Hardened Material	General Purpose	THN08921KITM0155GH		
				SNEU 1406ANER-AM PDL025	Non-Ferrous	General Purpose	THN08921KITEL025AM		

MA90 MILLING KITS  
MB45 MILLING KITS  
TURNING KITS  
CUT-OFF KITS

## Versatility + Quality

Large insert lineup supports a wide variety of machining applications

Five insert designs for various machining applications

Economical inserts with 8 cutting edges

General purpose GM insert with E-Class and M-Class options based on required machining accuracy

### SM (E Class) - Low Cutting Force

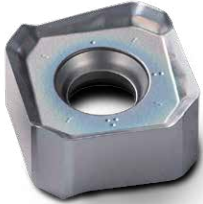

- Sharpness oriented with a low cutting force design
- -10% cutting resistance compared to general purpose GM insert
- Recommended for small machines (BT30)

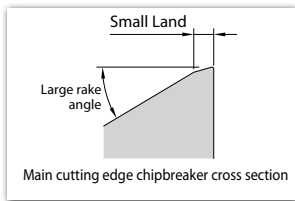

### GM (E/M Class) - General

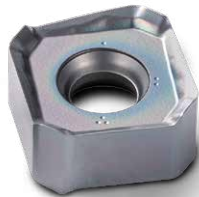

- 1st recommendation for steel machining
- Low cutting force and fracture resistance
- E-Class or M-Class selectable

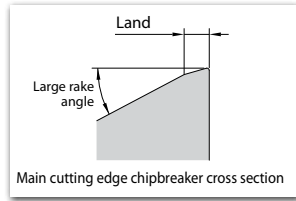

### GH (M Class) - Tough Edge



- Tough cutting edge and excellent fracture resistance
- Obtuse edge design is resistant to chipping
- Recommended for intermittent machining

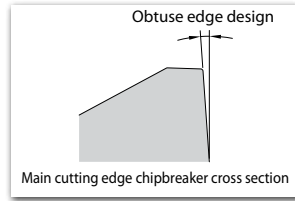

### AM for Aluminum Alloys

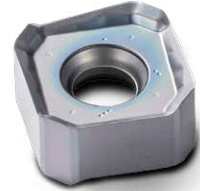

- No Land + Sharp Edge Specifications
- Excellent sharpness

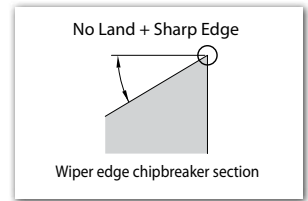

### Applicable Insert Range

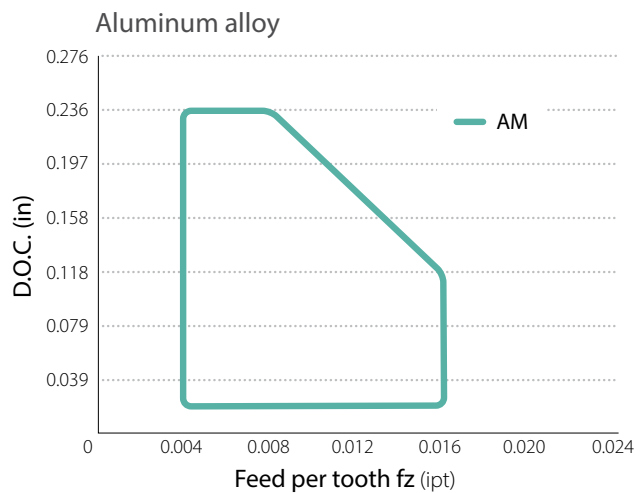
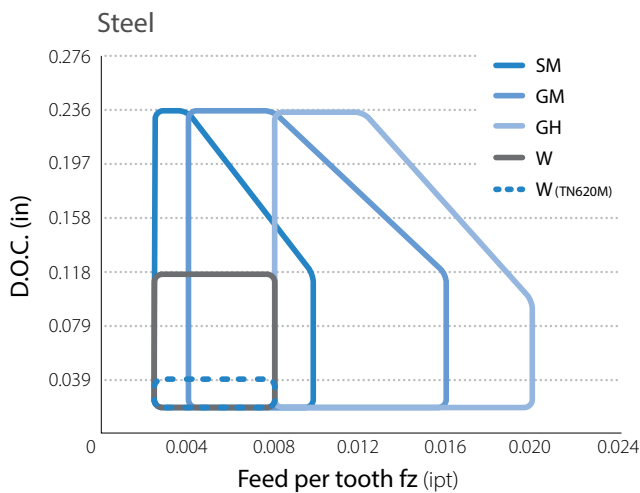

2024 Fall - 2025 Winter Promo Pack Offers valid through March 31, 2025

All promotional items are available exclusively through Authorized North American KYOCERA Precision Tool Distributors.

Please use specified Promo Code or Kit Part Number when placing orders. To locate a distributor visit [www.kyoceraprecisiontools.com/locate](http://www.kyoceraprecisiontools.com/locate).







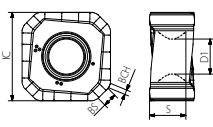

MA90 MILLING KITS

MB45 MILLING KITS

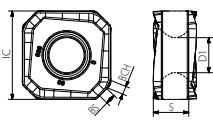
TURNING KITS

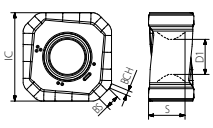
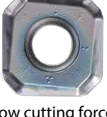
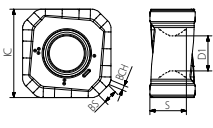
CUT-OFF KITS

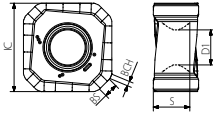
Applicable Inserts

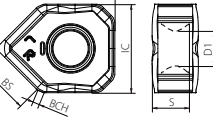
Usage Classification	P	Steel		★	☆					■							
		Mold steel		★	☆					■							
★: Roughing/ 1st recommendation	M	Austenitic stainless steel		☆	★												
		Martensitic stainless steel			☆					★							
☆: Roughing/ 2nd recommendation		Precipitation hardened stainless steel			★												
		K							★								
■: Finishing/ 1st recommendation		Gray cast iron								★							
		Ductile cast iron								★							
□: Finishing/ 2nd recommendation (Hardened material is 40 HRC or less)	N	Nonferrous metal														★	☆
		S												★			
	H	Heat resistant alloys (Ni-based heat resistant alloys)															
		Titanium alloy								★							
Shape	Description	Dimensions (in)							MEGACOAT NANO EX		NEW	MEGACOAT HARD	CVD Coated	Cermet	DLC Coated	Carbide	
		IC	S	BCH	BS	D1	INSL	PR1825	PR1835	PR1810	PR0155	CA6535	TN620M	PDL025	GW25		
 General Purpose (M-Class)		SNMU1406AER-GM	0.579	0.239	0.031	0.091	0.228	-	●	○	○	-	○	○	-	-	-
 Tough Edge (M-Class)		SNMU1406AER-GH	0.579	0.232	0.055	0.067	0.228	-	○	○	●	●	○	-	-	-	-
 General Purpose (E-Class)		SNEU1406AER-GM	0.579	0.239	0.031	0.091	0.228	-	●	○	○	-	○	○	-	-	-
 Low cutting force (E-Class)		SNEU1406ANER-SM	0.579	0.239	0.031	0.091	0.228	-	○	●	-	-	●	-	-	-	-
 Aluminum and non-ferrous metals (E-Class)		SNEU1406AFR-AM	0.579	0.239	0.031	0.091	0.228	-	-	-	-	-	-	-	●	○	-
 Wiper Insert (E-Class 2-edge)		SNEU1406ANEN-W	0.579	0.242	0.043	0.346	0.228	0.764	○	○	○	-	○	○	-	-	-

● : Available in Promo Kits  
○ : Available to be purchased separately



New CVD Coated Carbide Grade for Steel

# CA115P/CA125P

The new standard for steel machining

Longer tool life in a wide range of machining environments

Expanded lineup of chipbreakers for steel machining in various applications



View Online



Product Video



Product Brochure

## Application Map

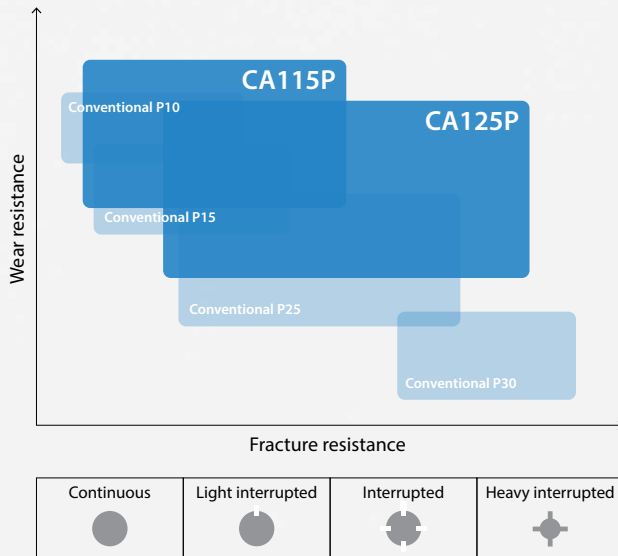

## CA115P

Continuous-light interrupted machining of steel

For high-efficiency machining with wear and chipping resistance

## CA125P

Continuous-heavy interrupted steel machining

First recommendation for steel machining  
High versatility



2024 Fall - 2025 Winter Promo Pack Offers valid through March 31, 2025

All promotional items are available exclusively through Authorized North American KYOCERA Precision Tool Distributors.

Please use specified Promo Code or Kit Part Number when placing orders. To locate a distributor visit [www.kyoceraprecisiontools.com/locate](http://www.kyoceraprecisiontools.com/locate).

## Advanced Technology

### New coating & carbide substrate



Black & Gold

Excellent wear and fracture resistance

## Innovative Layering Technology

### Ultra-uniform alumina layering

Proprietary crystal forming technology

Achieving significant crystal growth uniformity and direction

Reduces crater wear and extends tool life



## New Chipbreaker Design

### PMG Chipbreaker for Medium-Roughing

Unique design covers a wide range of machining applications

Maintains excellent chip control



MA90 MILLING KITS

MB45 MILLING KITS

TURNING KITS

CUT-OFF KITS

For medium-roughing

# PMG Chipbreaker

Covers a wide range of machining applications from medium machining to roughing  
 Excellent wear resistance with low cutting force design  
 Reduces chip shape inconsistencies and improves tool life

## Step breaker structure

Suppresses chip entanglement during large D.O.C. machining with a gently rising surface

## Circular Dot

Control chips during small D.O.C. machining

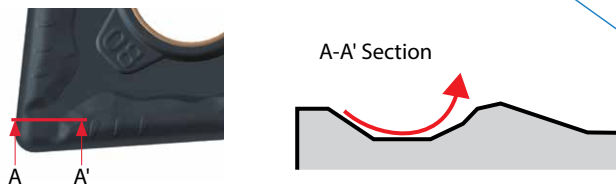

## High Rake Perimeter

Low resistance design suppresses rake face temperature rise  
 Reduces chipbreakers wear and chip shape changes

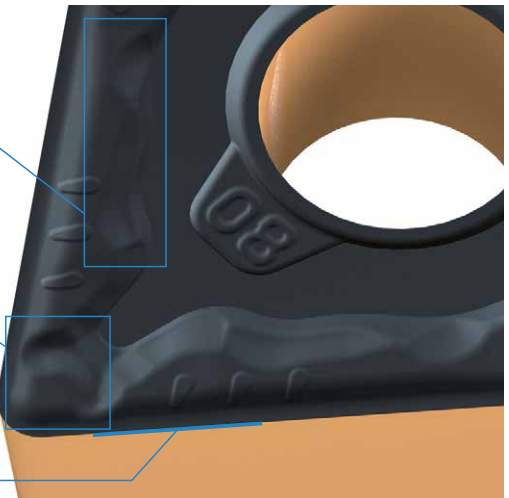

For finishing

# PP Chipbreaker

For Finishing  
 Low Resistance



## Applicable Chipbreaker Range

(D.O.C. indicates radial depth of cut)

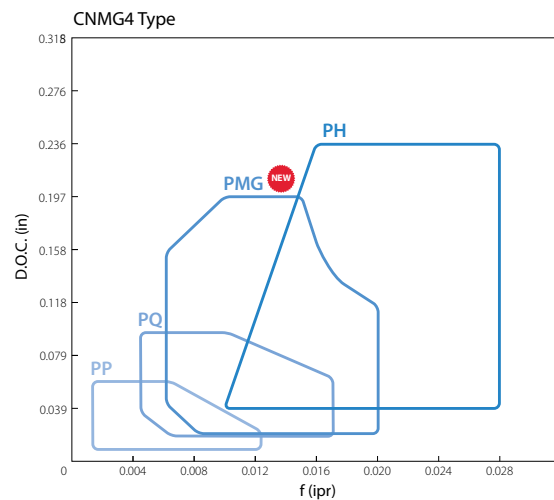

2024 Fall - 2025 Winter Promo Pack Offers valid through March 31, 2025

All promotional items are available exclusively through Authorized North American KYOCERA Precision Tool Distributors.

Please use specified Promo Code or Kit Part Number when placing orders. To locate a distributor visit [www.kyoceraprecisiontools.com/locate](http://www.kyoceraprecisiontools.com/locate).

MA90 MILLING KITS



MB45 MILLING KITS

TURNING KITS

CUT-OFF KITS

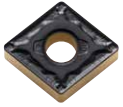
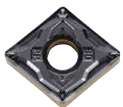
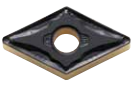
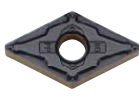
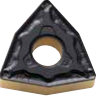

CA115P & CA125P Inserts

Usage Classification		P	Carbon Steel / Alloy Steel				★	☆
★ Continuous-Light Interrupted / 1st Choice ☆ Continuous-Heavy Interrupted / 1st Choice			Mold Steel				★	☆
Insert	Part Number	Dimensions (in)				CVD Coating	CVD Coating	
		IC	Thickness	Hole	Corner-R (RE)	CA115P	CA125P	
Medium-Roughing		CNMG 432PMG	1/2	3/16	0.203	1/32	●	●
Finishing							●	●
Medium-Roughing		DNMG 432PMG	1/2	3/16	0.203	1/32	●	●
Finishing							●	●
Medium-Roughing		WNMG 432PMG	1/2	3/16	0.203	1/32	●	●
Finishing							●	●
Finishing		VNMG 331PP	3/8	3/16	0.150	1/64	●	●

Recommended Cutting Conditions



Vc (sfm)

Insert		Low Carbon Steel Low Carbon Alloy Steel	Medium Carbon Steel Medium Carbon Alloy Steel	High Carbon Alloy Steel
		Up to 25 HRC		Up to 32 HRC
CA115P	Negative	490 ~ <b>980</b> ~ 1310		490 ~ <b>920</b> ~ 1180
	Positive	390 ~ <b>790</b> ~ 1050		360 ~ <b>720</b> ~ 950
CA125P	Negative	490 ~ <b>790</b> ~ 1050		490 ~ <b>720</b> ~ 920
	Positive	390 ~ <b>620</b> ~ 850		360 ~ <b>560</b> ~ 750

## Steel Turning Kits

Includes (1) Double-Clamp Turning Toolholder and (10) Inserts

Choose your Toolholder, Insert Chipbreaker, and Insert Grade

Pick 1 Toolholder Part Number		Shank Size (Square)	Overall Length	Insert	Pick 1 Chipbreaker	Pick 1 Grade	Kit Part Number (Use when Ordering)	\$USD Kit Price	\$CAD Kit Price
 <p>DCLN... Double-Clamp Turning Holder</p>	DCLNR 12-4B	0.750"	4.500"	CNMG432	PMG	CA115P	THC89560KITMGCA115	\$120.00	\$170.00
						CA125P	THC89560KITMGCA125		
					PP	CA115P	THC89560KITPPCA115		
						CA125P	THC89560KITPPCA125		
					PMG	CA115P	THC89600KITMGCA115		
						CA125P	THC89600KITMGCA125		
	DCLNR 16-4D	1.000"	6.000"		PMG	CA115P	THC89561KITMGCA115		
						CA125P	THC89561KITMGCA125		
					PP	CA115P	THC89561KITPPCA115		
						CA125P	THC89561KITPPCA125		
					PMG	CA115P	THC89601KITMGCA115		
						CA125P	THC89601KITMGCA125		
PP	CA115P	THC89601KITPPCA115							
	CA125P	THC89601KITPPCA125							
 <p>DDJN... Double-Clamp Turning Holder</p>	DDJNR 12-4B	0.750"	4.500"	DNMG432	PMG	CA115P	THC89568KITMGCA115	\$140.00	\$200.00
						CA125P	THC89568KITMGCA125		
					PP	CA115P	THC89568KITPPCA115		
						CA125P	THC89568KITPPCA125		
					PMG	CA115P	THC89608KITMGCA115		
						CA125P	THC89608KITMGCA125		
	PP	CA115P	THC89608KITPPCA115						
		CA125P	THC89608KITPPCA125						
	DDJNR 16-4D	1.000"	6.000"		PMG	CA115P	THC89569KITMGCA115		
						CA125P	THC89569KITMGCA125		
					PP	CA115P	THC89569KITPPCA115		
						CA125P	THC89569KITPPCA125		
PMG				CA115P	THC89609KITMGCA115				
				CA125P	THC89609KITMGCA125				
PP	CA115P	THC89609KITPPCA115							
	CA125P	THC89609KITPPCA125							

2024 Fall - 2025 Winter Promo Pack Offers valid through March 31, 2025

All promotional items are available exclusively through Authorized North American KYOCERA Precision Tool Distributors.

Please use specified Promo Code or Kit Part Number when placing orders. To locate a distributor visit [www.kyoceraprecisiontools.com/locate](http://www.kyoceraprecisiontools.com/locate).

## Steel Turning Kits

Includes (1) Double-Clamp Turning Toolholder and (10) Inserts

Choose your Toolholder, Insert Chipbreaker, and Insert Grade

Pick 1 Toolholder Part Number		Shank Size (Square)	Overall Length	Insert	Pick 1 Chipbreaker	Pick 1 Grade	Kit Part Number (Use when Ordering)	\$USD Kit Price	\$CAD Kit Price
 <p>DWLN... Double-Clamp Turning Holder</p>	DWLNR 12-4B	0.750"	4.500"	WNMG432	PMG	CA115P	THC89590KITMGCA115	\$120.00	\$170.00
						CA125P	THC89590KITMGCA125		
					PP	CA115P	THC89590KITPPCA115		
						CA125P	THC89590KITPPCA125		
	PMG	CA115P	THC89630KITMGCA115						
		CA125P	THC89630KITMGCA125						
	PP	CA115P	THC89630KITPPCA115						
		CA125P	THC89630KITPPCA125						
	DWLNR 16-4D	1.000"	6.000"		PMG	CA115P	THC89592KITMGCA115		
						CA125P	THC89592KITMGCA125		
					PP	CA115P	THC89592KITPPCA115		
						CA125P	THC89592KITPPCA125		
DWLNL 16-4D	1.000"	6.000"	PMG	CA115P	THC89632KITMGCA115				
				CA125P	THC89632KITMGCA125				
			PP	CA115P	THC89632KITPPCA115				
				CA125P	THC89632KITPPCA125				
 <p>DVJN... Double-Clamp Turning Holder</p>	DVJNR 12-3B	0.750"	4.500"	VNMG331	PP	CA115P	THC89585KITPPCA115	\$140.00	\$200.00
						CA125P	THC89585KITPPCA125		
	DVJNL 12-3B	0.750"	4.500"		PP	CA115P	THC89625KITPPCA115		
						CA125P	THC89625KITPPCA125		
	DVJNR 16-3D	1.000"	6.000"		PP	CA115P	THC89586KITPPCA115		
						CA125P	THC89586KITPPCA125		
	DVJNL 16-3D	1.000"	6.000"		PP	CA115P	THC89626KITPPCA115		
						CA125P	THC89626KITPPCA125		

MA90 MILLING KITS

MB45 MILLING KITS

TURNING KITS

CUT-OFF KITS

PVD Coating for Heat-Resistant Alloy

## PR115S/PR120S NEW



View Online



Product Video



Product Brochure

Unique carbide substrate with excellent heat-resistant properties and new coating technology “MEGACOAT TOUGH” provides longer tool life for heat-resistant alloy machining. Low cutting force and stable machining with specialized chipbreakers.

### PR115S

Covers a wide range of difficult-to-cut material machining applications  
1st recommendation for continuous finishing of heat-resistant alloys

### PR120S

Long tool life and stable machining in interrupted machining of heat-resistant alloys  
1st recommendation for continuous finishing to light interrupted machining of stainless steel  
Longer tool life extension possible for stainless steel machining

**S** Heat-Resistant Alloys Application map

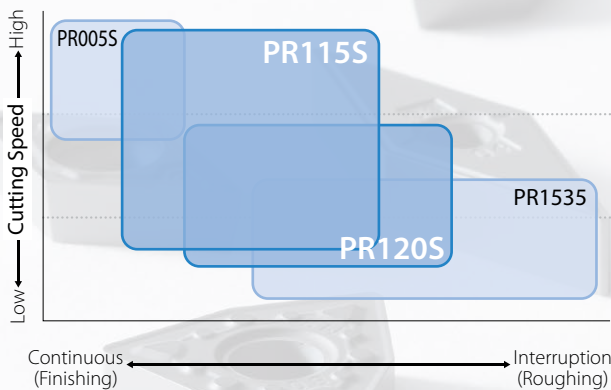

**M** Stainless Steel Application map

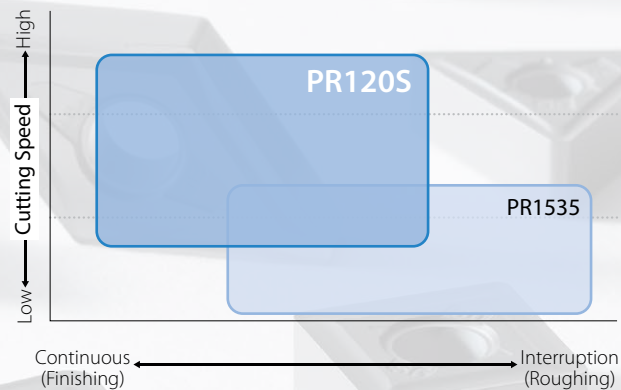

### Applicable Chipbreaker Range (D.O.C. Indicates radial depth of cut per side)

#### Heat-Resistant Alloys

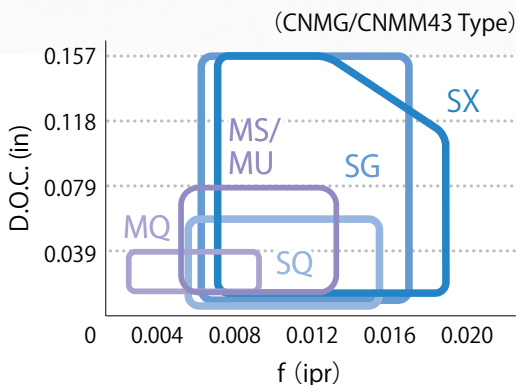

#### Stainless Steel

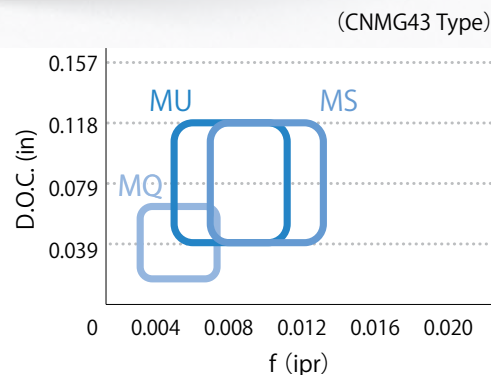

2024 Fall - 2025 Winter Promo Pack Offers valid through March 31, 2025











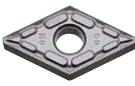

All promotional items are available exclusively through Authorized North American KYOCERA Precision Tool Distributors.

Please use specified Promo Code or Kit Part Number when placing orders. To locate a distributor visit [www.kyoceraprecisiontools.com/locate](http://www.kyoceraprecisiontools.com/locate).

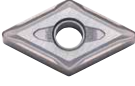
MA90 MILLING KITS  
MB45 MILLING KITS  
TURNING KITS  
CUT-OFF KITS



## PR115S & PR120S Inserts



Usage Classification								
★ 1st Choice ☆ 2nd Choice	M	Stainless Steel					☆	★
	S	Heat-Resistant Alloy					★	☆
Insert	Part Number	Dimensions (in)				PVD Coating		
		IC	Thickness	Hole	Corner-R (RE)	PR115S	PR120S	
Finishing-Medium		<b>CNMG 432MQ</b>	1/2	3/16	0.203	1/32	●	●
Medium-Roughing		<b>CNMG 432MS</b>					●	●
Roughing		<b>CNMG 432SG</b>					●	●
Finishing-Medium		<b>CNMG432SQ</b>					●	●
Finishing-Medium		<b>DNMG 432MQ</b>	1/2	3/16	0.203	1/32	●	●
Medium-Roughing		<b>DNMG 432MS</b>					●	●
Roughing		<b>DNMG 432SG</b>					●	●
Finishing-Medium		<b>DNMG 432SQ</b>					●	●
Finishing-Medium		<b>WNMG 432MQ</b>	1/2	3/16	0.203	1/32	●	●
Medium-Roughing		<b>WNMG 432MS</b>					●	●
Roughing		<b>WNMG 432SG</b>					●	●
Finishing-Medium		<b>VNMG331 MQ</b>	3/8	3/16	0.150	1/64	●	●
Medium-Roughing		<b>VNMG331 MS</b>					●	●

MA90 MILLING KITS  
MB45 MILLING KITS  
TURNING KITS  
CUT-OFF KITS

## Stainless & Heat-Resistant Alloy Turning Kits

Includes (1) Double-Clamp Turning Toolholder and (10) Inserts

Choose your Toolholder, Insert Chipbreaker, and Insert Grade

Pick 1 Toolholder Part Number		Shank Size (Square)	Overall Length	Pick 1 Insert	Pick 1 Chipbreaker	Grade	Kit Part Number (Use when Ordering)	\$USD Kit Price	\$CAD Kit Price
 DCLN... Double-Clamp Turning Holder	DCLNR 12-4B	0.750"	4.500"	CNMG432	MQ	PR115S	THC89560KITMQPR115	\$120.00	\$170.00
						PR120S	THC89560KITMQPR120		
					MS	PR115S	THC89560KITMSPR115		
						PR120S	THC89560KITMSPR120		
					SG	PR115S	THC89560KITSGPR115		
						PR120S	THC89560KITSGPR120		
					SQ	PR115S	THC89560KITSQPR115		
						PR120S	THC89560KITSQPR120		
					MQ	PR115S	THC89600KITMQPR115		
						PR120S	THC89600KITMQPR120		
	MS	PR115S	THC89600KITMSPR115						
		PR120S	THC89600KITMSPR120						
	SG	PR115S	THC89600KITSGPR115						
		PR120S	THC89600KITSGPR120						
	SQ	PR115S	THC89600KITSQPR115						
		PR120S	THC89600KITSQPR120						
	DCLNR 16-4D	1.000"	6.000"		MQ	PR115S	THC89561KITMQPR115		
						PR120S	THC89561KITMQPR120		
					MS	PR115S	THC89561KITMSPR115		
						PR120S	THC89561KITMSPR120		
SG				PR115S	THC89561KITSGPR115				
				PR120S	THC89561KITSGPR120				
SQ				PR115S	THC89561KITSQPR115				
				PR120S	THC89561KITSQPR120				
MQ				PR115S	THC89601KITMQPR115				
				PR120S	THC89601KITMQPR120				
MS	PR115S	THC89601KITMSPR115							
	PR120S	THC89601KITMSPR120							
SG	PR115S	THC89601KITSGPR115							
	PR120S	THC89601KITSGPR120							
SQ	PR115S	THC89601KITSQPR115							
	PR120S	THC89601KITSQPR120							
 DDJN... Double-Clamp Turning Holder	DDJNR 12-4B	0.750"	4.500"	DNMG432	MQ	PR115S	THC89568KITMQPR115	\$140.00	\$200.00
						PR120S	THC89568KITMQPR120		
					MS	PR115S	THC89568KITMSPR115		
						PR120S	THC89568KITMSPR120		
					SG	PR115S	THC89568KITSGPR115		
						PR120S	THC89568KITSGPR120		
					SQ	PR115S	THC89568KITSQPR115		
						PR120S	THC89568KITSQPR120		
					MQ	PR115S	THC89608KITMQPR115		
						PR120S	THC89608KITMQPR120		
	MS	PR115S	THC89608KITMSPR115						
		PR120S	THC89608KITMSPR120						
	SG	PR115S	THC89608KITSGPR115						
		PR120S	THC89608KITSGPR120						
	SQ	PR115S	THC89608KITSQPR115						
		PR120S	THC89608KITSQPR120						
	MQ	PR115S	THC89569KITMQPR115						
		PR120S	THC89569KITMQPR120						
	MS	PR115S	THC89569KITMSPR115						
		PR120S	THC89569KITMSPR120						
SG	PR115S	THC89569KITSGPR115							
	PR120S	THC89569KITSGPR120							
SQ	PR115S	THC89569KITSQPR115							
	PR120S	THC89569KITSQPR120							
MQ	PR115S	THC89609KITMQPR115							
	PR120S	THC89609KITMQPR120							
MS	PR115S	THC89609KITMSPR115							
	PR120S	THC89609KITMSPR120							
SG	PR115S	THC89609KITSGPR115							
	PR120S	THC89609KITSGPR120							
SQ	PR115S	THC89609KITSQPR115							
	PR120S	THC89609KITSQPR120							

2024 Fall - 2025 Winter Promo Pack Offers valid through March 31, 2025

All promotional items are available exclusively through Authorized North American KYOCERA Precision Tool Distributors.

Please use specified Promo Code or Kit Part Number when placing orders. To locate a distributor visit [www.kyoceraprecisiontools.com/locate](http://www.kyoceraprecisiontools.com/locate).

MA90 MILLING KITS

MB45 MILLING KITS



TURNING KITS

CUT-OFF KITS

## Stainless & Heat-Resistant Alloy Turning Kits

Includes (1) Double-Clamp Turning Toolholder and (10) Inserts

Choose your Toolholder, Insert Chipbreaker, and Insert Grade

Pick 1 Toolholder Part Number		Shank Size (Square)	Overall Length	Pick 1 Insert	Pick 1 Chipbreaker	Grade	Kit Part Number (Use when Ordering)	\$USD Kit Price	\$CAD Kit Price
 <p>DWLN... Double-Clamp Turning Holder</p>	DWLNR 12-4B	0.750"	4.500"	WNMG432	MQ	PR115S	THC89590KITMQPR115	\$120.00	\$170.00
						PR120S	THC89590KITMQPR120		
					MS	PR115S	THC89590KITMSPR115		
						PR120S	THC89590KITMSPR120		
					SG	PR115S	THC89590KITSGPR115		
						PR120S	THC89590KITSGPR120		
	DWLNL 12-4B	0.750"	4.500"		MQ	PR115S	THC89630KITMQPR115		
						PR120S	THC89630KITMQPR120		
					MS	PR115S	THC89630KITMSPR115		
						PR120S	THC89630KITMSPR120		
					SG	PR115S	THC89630KITSGPR115		
						PR120S	THC89630KITSGPR120		
	DWLNR 16-4D	1.000"	6.000"		MQ	PR115S	THC89592KITMQPR115		
						PR120S	THC89592KITMQPR120		
MS				PR115S	THC89592KITMSPR115				
				PR120S	THC89592KITMSPR120				
SG				PR115S	THC89592KITSGPR115				
				PR120S	THC89592KITSGPR120				
DWLNL 16-4D	1.000"	6.000"	MQ	PR115S	THC89632KITMQPR115				
				PR120S	THC89632KITMQPR120				
			MS	PR115S	THC89632KITMSPR115				
				PR120S	THC89632KITMSPR120				
			SG	PR115S	THC89632KITSGPR115				
				PR120S	THC89632KITSGPR120				
 <p>DVJN... Double-Clamp Turning Holder</p>	DVJNR 12-3B	0.750"	4.500"	VNMG331	MQ	PR115S	THC89585KITMQPR115	\$140.00	\$200.00
						PR120S	THC89585KITMQPR120		
					MS	PR115S	THC89585KITMSPR115		
						PR120S	THC89585KITMSPR120		
					SG	PR115S	THC89585KITSGPR115		
						PR120S	THC89585KITSGPR120		
	DVJNL 12-3B	0.750"	4.500"		MQ	PR115S	THC89625KITMQPR115		
						PR120S	THC89625KITMQPR120		
					MS	PR115S	THC89625KITMSPR115		
						PR120S	THC89625KITMSPR120		
					SG	PR115S	THC89625KITSGPR115		
						PR120S	THC89625KITSGPR120		
	DVJNR 16-3D	1.000"	6.000"		MQ	PR115S	THC89586KITMQPR115		
						PR120S	THC89586KITMQPR120		
					MS	PR115S	THC89586KITMSPR115		
						PR120S	THC89586KITMSPR120		
					SG	PR115S	THC89586KITSGPR115		
						PR120S	THC89586KITSGPR120		
DVJNL 16-3D	1.000"	6.000"	MQ	PR115S	THC89626KITMQPR115				
				PR120S	THC89626KITMQPR120				
			MS	PR115S	THC89626KITMSPR115				
				PR120S	THC89626KITMSPR120				
			SG	PR115S	THC89626KITSGPR115				
				PR120S	THC89626KITSGPR120				

MA90 MILLING KITS

MB45 MILLING KITS

TURNING KITS

CUT-OFF KITS

Cut-Off Solutions for Small Parts Machining

# KGZ NEW



View Online



Product Video



Product Brochure

Provides stable machining and is easy to use with unique clamp design

New coating PR20 series provides longer tool life and supports a wide range of applications

## Stable machining with sturdy clamp design

- Greater chatter resistance provides excellent surface finish and stable tool life
- Toolholder durability reduces down-time and cuts cost
- Supports high efficiency machining and reduces cycle time

## Easy insert management

- Fast and secure insert installation
- Inserts are more resistant to wear and reduce the frequency of tool changes



## Toolholder Sturdy clamps

### Three unique features

**1. Gap section**  
Tapered slit

**2. Top clamp**  
Pulls insert down and back

**3. Stopper**  
Obtuse angle stopper

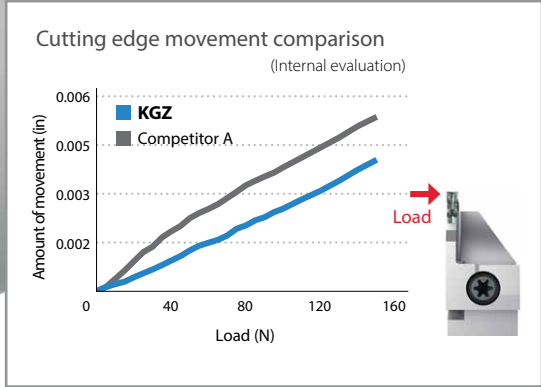

2024 Fall - 2025 Winter Promo Pack Offers valid through March 31, 2025

All promotional items are available exclusively through Authorized North American KYOCERA Precision Tool Distributors.

Please use specified Promo Code or Kit Part Number when placing orders. To locate a distributor visit [www.kyoceraprecisiontools.com/locate](http://www.kyoceraprecisiontools.com/locate).

MA90 MILLING KITS

MB45 MILLING KITS

TURNING KITS

CUT-OFF KITS



**Insert** Ease insert installation

**Top V Shape** Different groove angles at ends and center

**Groove End**

Small groove angle on top of insert

These grooves prevent the insert from shifting and provide fast and accurate insert mounts

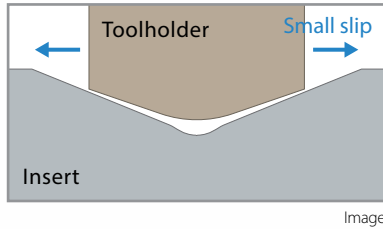

**Center of groove**

Large groove angle on top of insert

Firmly engages the toolholder to increase hold

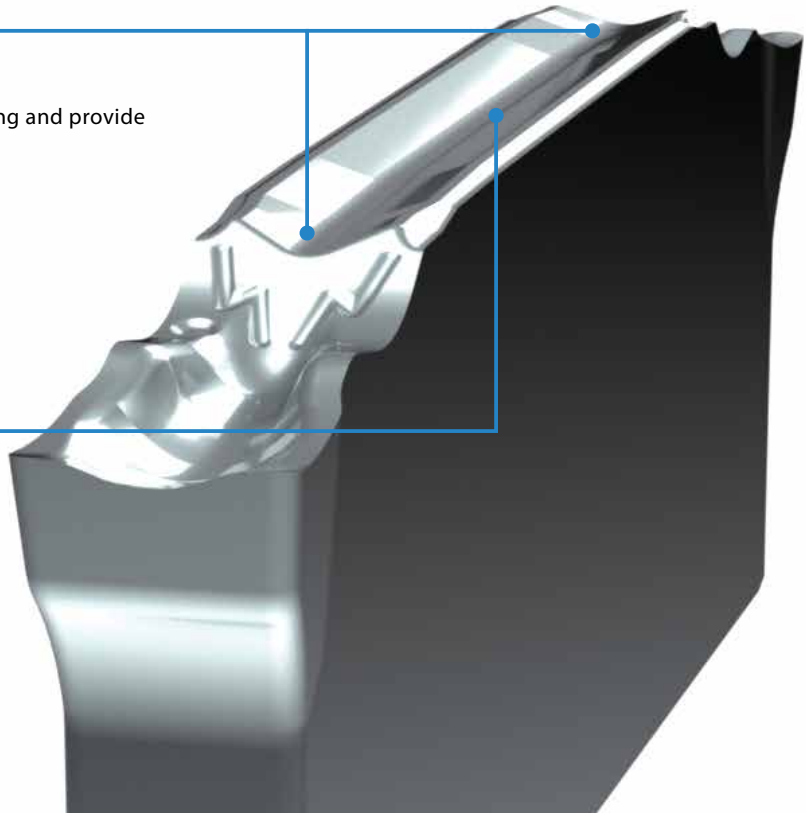
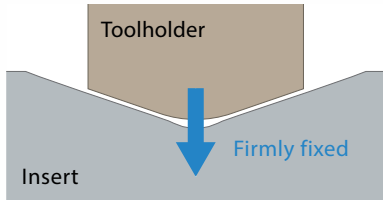

New insert grades for grooving and cut-off solutions

**PR20 Series**

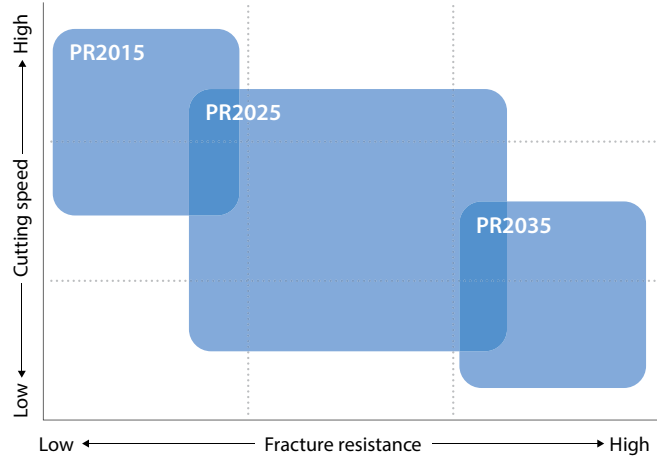

- PR2015** 1st recommendation for cast iron  
Also available for steel and stainless steel
- PR2025** 1st recommendation for steel  
Also available for stainless steel
- PR2035** 1st recommendation for stainless steel  
Also available for steel

<b>Insert</b> CW : 0.051" - 0.118"	Low feed <b>PF</b>	Medium feed <b>PM</b>	High feed <b>PH</b>	Low cutting force <b>PG</b>	PVD coating <b>P M K</b> <b>PR2015 / PR2025 / PR2035</b> <b>NEW</b>
					DLC coating <b>N</b> Non-coated carbide <b>K N</b> <b>PDL025</b> <b>GW15</b>

<b>Toolholder Styles</b>	<b>Internal coolant</b> JCTM Series for direct coolant	<b>External coolant</b> Standard type / for Sub-spindle tooling
--------------------------	---	--

KYOCERA Precision Tools

P : 800.823.7284 • E : [ctsales@kyocerapti.com](mailto:ctsales@kyocerapti.com)

Official Website : [www.kyoceraprecisiontools.com](http://www.kyoceraprecisiontools.com) • Distributor Website : [portal.kyoceraprecisiontools.com](http://portal.kyoceraprecisiontools.com)

MA90 MILLING KITS

MB45 MILLING KITS

TURNING KITS

CUT-OFF KITS

## KGZ (Standard Toolholder) Kits

Includes (1) Toolholder and (10) Inserts

Choose your Toolholder and Insert



Cutting Width (CW)	Pick 1 Toolholder	Hand	Shank Size (Square)	CUTDIA	Pick 1 Insert	Insert Lead Angle	Application	Grade	Kit Part Number (Use when Ordering)	\$USD Kit Price	\$CAD Kit Price
0.0591" (1.5mm)	KGZL 8-1.5JX	Left	0.500"	0.945"	GZM1516L-003PF-15D	15° Left-Hand	Low Feed	PR2035	THC89890KIT1_15L35	\$175.00	\$250.00
					GZM1516N-015PF	Neutral	Low Feed		THC89890KIT2_15N35		
	KGZR 8-1.5JX	Right	0.500"	0.945"	GZM1516R-015PF-15D	15° Right-Hand	Low Feed		THC89889KIT3_15R35		
					GZM1516N-015PF	Neutral	Low Feed		THC89889KIT4_15N35		
0.079" (2.00mm)	KGZL 8-2JX	Left	0.500"	0.945"	GZM2020N-015PF	Neutral	Low Feed	PR2035	THC89894KIT1_20N35	\$175.00	\$250.00
					GZM2020N-020PH	Neutral	High Feed		THC89894KIT2_20N35		
					GZM2020N-020PM	Neutral	Medium Feed		THC89894KIT3_20N35		
					GZM2020R-015PF-15D	15° Right-Hand	Low Feed		THC89894KIT4_20R35		
	KGZR 8-2JX	Right	0.500"	0.945"	GZM2020N-015PF	Neutral	Low Feed	PR2035	THC89893KIT1_20N35	\$175.00	\$250.00
					GZM2020N-020PH	Neutral	High Feed		THC89893KIT2_20N35		
					GZM2020N-020PM	Neutral	Medium Feed		THC89893KIT3_20N35		
					GZM2020R-015PF-15D	15° Right-Hand	Low Feed		THC89893KIT4_20R35		
	KGZL 10-2JX	Left	0.625"	1.260"	GZM2020N-015PF	Neutral	Low Feed	PR2035	THC89896KIT1_20N35	\$175.00	\$250.00
					GZM2020N-020PH	Neutral	High Feed		THC89896KIT2_20N35		
					GZM2020N-020PM	Neutral	Medium Feed		THC89896KIT3_20N35		
					GZM2020R-015PF-15D	15° Right-Hand	Low Feed		THC89896KIT4_20R35		
KGZR 10-2JX	Right	0.625"	1.260"	GZM2020N-015PF	Neutral	Low Feed	PR2035	THC89895KIT1_20N35	\$175.00	\$250.00	
				GZM2020N-020PH	Neutral	High Feed		THC89895KIT2_20N35			
				GZM2020N-020PM	Neutral	Medium Feed		THC89895KIT3_20N35			
				GZM2020R-015PF-15D	15° Right-Hand	Low Feed		THC89895KIT4_20R35			
0.118" (3.00mm)	KGZL 8-3JX	Left	0.500"	0.945"	GZM3020N-015PF	Neutral	Low Feed	PR2035	THC89904KIT1_30N35	\$175.00	\$250.00
					GZM3020N-025PM	Neutral	Medium Feed		THC89904KIT2_30N35		
					GZM3020N-030PH	Neutral	High Feed		THC89904KIT3_30N35		
					GZM3020R-015PF-15D	15° Right-Hand	Low Feed		THC89904KIT4_30R35		
	KGZR 8-3JX	Right	0.500"	0.945"	GZM3020N-015PF	Neutral	Low Feed	PR2035	THC89903KIT1_30N35	\$175.00	\$250.00
					GZM3020N-025PM	Neutral	Medium Feed		THC89903KIT2_30N35		
					GZM3020N-030PH	Neutral	High Feed		THC89903KIT3_30N35		
					GZM3020R-015PF-15D	15° Right-Hand	Low Feed		THC89903KIT4_30R35		
	KGZL 10-3JX	Left	0.625"	1.260"	GZM3020N-015PF	Neutral	Low Feed	PR2035	THC89906KIT1_30N35	\$175.00	\$250.00
					GZM3020N-025PM	Neutral	Medium Feed		THC89906KIT2_30N35		
					GZM3020N-030PH	Neutral	High Feed		THC89906KIT3_30N35		
					GZM3020R-015PF-15D	15° Right-Hand	Low Feed		THC89906KIT4_30R35		
KGZR 10-3JX	Right	0.625"	1.260"	GZM3020N-015PF	Neutral	Low Feed	PR2035	THC89905KIT1_30N35	\$175.00	\$250.00	
				GZM3020N-025PM	Neutral	Medium Feed		THC89905KIT2_30N35			
				GZM3020N-030PH	Neutral	High Feed		THC89905KIT3_30N35			
				GZM3020R-015PF-15D	15° Right-Hand	Low Feed		THC89905KIT4_30R35			

2024 Fall - 2025 Winter Promo Pack Offers valid through March 31, 2025

All promotional items are available exclusively through Authorized North American KYOCERA Precision Tool Distributors.

Please use specified Promo Code or Kit Part Number when placing orders. To locate a distributor visit [www.kyoceraprecisiontools.com/locate](http://www.kyoceraprecisiontools.com/locate).

MA90 MILLING KITS

MB45 MILLING KITS

TURNING KITS

CUT-OFF KITS

## KGZ-JCTM (Jet Coolant-Through) Kits

Includes (1) Toolholder and (10) Inserts

Choose your Toolholder and Insert



Cutting Width (CW)	Pick 1 Toolholder	Hand	Shank Size (Square)	CUTDIA	Pick 1 Insert	Insert Lead Angle	Application	Grade	Kit Part Number (Use when Ordering)	\$USD Kit Price	\$CAD Kit Price
0.079" (2.00mm)	KGZL 8-2JCTM	Left	0.500"	0.945"	GZM2020N-015PF	Neutral	Low Feed	PR2035	THC89926KIT1_20N35	\$195.00	\$280.00
					GZM2020N-020PH	Neutral	High Feed		THC89926KIT2_20N35		
					GZM2020N-020PM	Neutral	Medium Feed		THC89926KIT3_20N35		
					GZM2020R-015PF-15D	15° Right-Hand	Low Feed		THC89926KIT4_20R35		
	KGZR 8-2JCTM	Right	0.500"	0.945"	GZM2020N-015PF	Neutral	Low Feed	PR2035	THC89925KIT1_20N35	\$195.00	\$280.00
					GZM2020N-020PH	Neutral	High Feed		THC89925KIT2_20N35		
					GZM2020N-020PM	Neutral	Medium Feed		THC89925KIT3_20N35		
					GZM2020R-015PF-15D	15° Right-Hand	Low Feed		THC89925KIT4_20R35		
	KGZL 10-2JCTM	Left	0.625"	1.260"	GZM2020N-015PF	Neutral	Low Feed	PR2035	THC89928KIT1_20N35	\$195.00	\$280.00
					GZM2020N-020PH	Neutral	High Feed		THC89928KIT2_20N35		
					GZM2020N-020PM	Neutral	Medium Feed		THC89928KIT3_20N35		
					GZM2020R-015PF-15D	15° Right-Hand	Low Feed		THC89928KIT4_20R35		
	KGZR 10-2JCTM	Right	0.625"	1.260"	GZM2020N-015PF	Neutral	Low Feed	PR2035	THC89927KIT1_20N35	\$195.00	\$280.00
					GZM2020N-020PH	Neutral	High Feed		THC89927KIT2_20N35		
					GZM2020N-020PM	Neutral	Medium Feed		THC89927KIT3_20N35		
					GZM2020R-015PF-15D	15° Right-Hand	Low Feed		THC89927KIT4_20R35		
0.118" (3.00mm)	KGZL 8-3JCTM	Left	0.500"	0.945"	GZM3020N-015PF	Neutral	Low Feed	PR2035	THC89934KIT1_30N35	\$195.00	\$280.00
					GZM3020N-025PM	Neutral	Medium Feed		THC89934KIT2_30N35		
					GZM3020N-030PH	Neutral	High Feed		THC89934KIT3_30N35		
					GZM3020R-015PF-15D	15° Right-Hand	Low Feed		THC89934KIT4_30R35		
	KGZR 8-3JCTM	Right	0.500"	0.945"	GZM3020N-015PF	Neutral	Low Feed	PR2035	THC89933KIT1_30N35	\$195.00	\$280.00
					GZM3020N-025PM	Neutral	Medium Feed		THC89933KIT2_30N35		
					GZM3020N-030PH	Neutral	High Feed		THC89933KIT3_30N35		
					GZM3020R-015PF-15D	15° Right-Hand	Low Feed		THC89933KIT4_30R35		
	KGZL 10-3JCTM	Left	0.625"	1.260"	GZM3020N-015PF	Neutral	Low Feed	PR2035	THC89936KIT1_30N35	\$195.00	\$280.00
					GZM3020N-025PM	Neutral	Medium Feed		THC89936KIT2_30N35		
					GZM3020N-030PH	Neutral	High Feed		THC89936KIT3_30N35		
					GZM3020R-015PF-15D	15° Right-Hand	Low Feed		THC89936KIT4_30R35		
	KGZR 10-3JCTM	Right	0.625"	1.260"	GZM3020N-015PF	Neutral	Low Feed	PR2035	THC89935KIT1_30N35	\$195.00	\$280.00
					GZM3020N-025PM	Neutral	Medium Feed		THC89935KIT2_30N35		
					GZM3020N-030PH	Neutral	High Feed		THC89935KIT3_30N35		
					GZM3020R-015PF-15D	15° Right-Hand	Low Feed		THC89935KIT4_30R35		









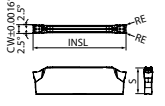

MA90 MILLING KITS

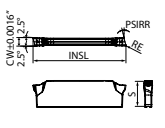
MB45 MILLING KITS

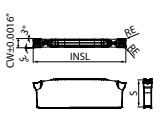
TURNING KITS

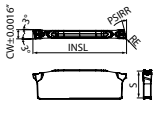
CUT-OFF KITS

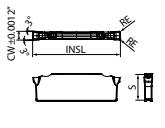
# GZM Inserts

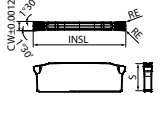
Shape	Description	No. of Edges	Dimensions (mm)						Angle	MEGACOAT NANO EX		
			CW			S	RE	INSL	PSIR $\frac{R}{L}$	PR2035		
			inch	mm	Tolerance							
Handed insert shows Right-hand												
Low Feed			GZM 1516N-015PF	2	0.059	1.5	+0.0016" -0.0016"	4.4	0.15	16	-	●
			GZM 1516L-003PF-15D	2	0.059	1.5	+0.0016" -0.0016"	4.4	0.03	16	15°	●
			1516R-015PF-15D						0.15			●
			GZM 2020N-015PF	2	0.079	2	+0.0016" -0.0016"	5.9	0.15	20	-	●
3020N-015PF			0.118		3	●						
		GZM 2020R-015PF-15D	2	0.079	2	+0.0016" -0.0016"	5.9	0.15	20	15°	●	
		3020R-015PF-15D		0.118	3						●	
Medium Feed			GZM 2020N-020PM	2	0.079	2	+0.0012" -0.0012"	5.9	0.2	20	-	●
			3020N-025PM		0.118	3	+0.0012" -0.0012"		0.25			●
High Feed			GZM 2020N-020PH	2	0.079	2	+0.0012" -0.0012"	5.9	0.2	20	-	●
			3020N-030PH		0.118	3			0.3			●

Using PF or PM chipbreaker for grooving will not create a flat bottom.

●: Standard Stock

## Recommended Cutting Conditions ★1st recommendation ☆2nd recommendation

Workpiece	Vc (sfm)	f (ipr)								Notes
		PF (RE = 0.0012")			PF (RE = 0.0059")			PM	PH	
		CW								
MEGACOAT NANO EX	PR2035	0.051"~0.059" (1.3mm~1.5mm)	0.079" (2mm)	0.098"~0.118" (2.5mm~3.0mm)	0.051~0.059 (1.3mm~1.5mm)	0.079" (2mm)	0.098"~0.118" (2.5mm~3.0mm)	0.079~0.118" (2mm~3mm)	0.079~0.118" (2mm~3mm)	
Carbon Steel	230~490	0.0004~0.0016	0.0008~0.0024	0.0008~0.0031	0.0004~0.002	0.0012~0.0031	0.0016~0.0031	0.0020~0.0059	0.0039~0.0079	Wet
Alloy Steel	230~490									
Stainless Steel	200~390	0.0004~0.0012	0.0004~0.0016	0.0004~0.0020	0.0004~0.0016	0.0012~0.0028	0.0016~0.0031	0.0016~0.0047	0.0031~0.0063	



### KYOCERA Precision Tools

238 Marc Drive  
Cuyahoga Falls, OH 44223  
Customer Service | 800.823.7284 - Option 1  
Technical Support | 800.823.7284 - Option 2



Official Website | [www.kyoceraprecisiontools.com](http://www.kyoceraprecisiontools.com)  
Distributor Website | [portal.kyoceraprecisiontools.com](http://portal.kyoceraprecisiontools.com)  
Email | [ctsales@kyocerapti.com](mailto:ctsales@kyocerapti.com)



©KYOCERA Precision Tools  
10/2024